

GSH XPERT SOLUTIONS
YOUR NEEDS, OUR PRIORITY

PARRROT
PRODUCTS
A Zero Defect Supplier

General Catalogue



A zero defect supplier

Why we exist

Our purpose is to secure ourselves as a contributor to your business success.
Our dealer base includes major retailers and our customers Blue Chip organisations

We are solution providers with active support structures in place, assisting in the sales process through to the final satisfied purchase.

We invite you to experience our commitment to you, discuss the following opportunities with your local sales team:

- National free delivery to all major cities with our in-house extensive delivery fleet - ensuring on time delivery of undamaged goods
- Training Centres & showrooms in major city centres throughout SA – for use by you and your customers
- Make use of our state of the art showrooms and invite your sales team and/or your key clients for in-depth knowledge on our extensive range
- Marketing support
- Personalised catalogues of our full range
- We invest in our dealer base by providing consignment stock models that are managed, administered, merchandised & consistently reviewed - with you - by Parrot staff. Increased returns on investment with no capital requirements.
- Proof of Concepts – to assist your customer in making the right decision
- Demonstrations
- Joint sales calls – supporting you with on-site advice and assisting the sales process
- Our in-house IT department facilitates integration of the Parrot ERP with your in-house program, ensuring lower admin costs and speed of transacting
- Professional installation services of any of our product range, in Gauteng, Bloemfontein, Nelspruit, Durban, Cape Town, Port Elizabeth & Namibia. Providing free quotations, turnkey solutions of Pre-sales, In-sales and After-sales from friendly and efficient teams.
- Through our Parrot online experience view national stock levels, PODs, Invoices, Credit Notes & Statements. Quotations can be processed online and converted to order, providing ease and convenience for online ordering.

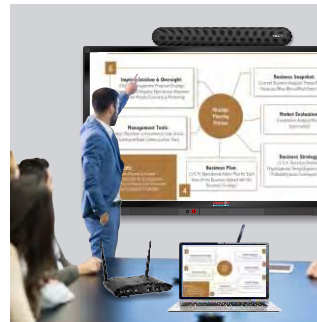

Who are we ?

Parrot Products was created in 1992, driven by its founders for a desire to service the presentation and education industries with locally manufactured quality products, on a national basis at unprecedented speed. **OUR RANGE NEXT DAY.**

We consider ourselves market leaders in the ranges of products we supply. Customised solutions are available throughout our range.

Our four clearly defined product categories are, **Office Equipment, Interactive, Display and Janitorial.**



An inside look

We are an ISO certified company, evidence of the fact that we believe a quality organisation produces quality people and product. Our manufacturing and warehousing plant is situated in Cleveland, Johannesburg and operates from a site spanning 12000 square metres.

With fully stocked branches in Johannesburg, Cape Town, Durban, Bloemfontein, Nelspruit, Port Elizabeth, Namibia, Gaborone and Lusaka, our team is motivated and continually excited to ensure our Dealers and their customers receive excellent products from a high quality brand. A centralised national call centre is on standby to administer product support information and processing of orders & quotes.

Throughout its history and into the present day, Parrot Products continues to innovate and diversify in an effort to offer a wider range of products, contributing to our Dealers success.

With over 60% of product manufactured locally and with a staff compliment of over 300 staff members, Parrot Products are a proudly South African concern.



Contents

Boards

| | |
|---|-------|
| Slimline Whiteboards - Magnetic & Non-magnetic | 1 - 2 |
| Whiteboards - Magnetic & Non-magnetic | 3 - 4 |
| Alufine Magnetic Whiteboard | 5 |
| Floating Glass Whiteboard | 5 |
| Glass Whiteboards Printed - Magnetic & Non-magnetic | 6 - 8 |
| Chalk Boards - Magnetic & Non-Magnetic | 9 |
| Educational Boards | 10-12 |
| Installations | 13 |
| Writing Slates & Clipboards | 14-16 |
| Whiteboard Mini Tiles - Magnetic, Flexi Magnetic | 17 |
| Pin Boards, Self Adhesive, No Frame | 18 |
| Info Boards, Felt - Alufine Frame & Aluminium Frame | 19-20 |
| Bulletin Boards, New Ribbed Carpet | 21 |
| Combi Boards, Non-magnetic | 22 |
| Display Cases | 23 |
| Flipcharts - Standard Models & Glass | 24-26 |
| Flipcharts - Standard Carry Bag | 27 |
| Flipcharts - Paper Carrier & Paper | 27 |
| Board Support, T-legs, Easel & Desk Partition Clamp | 28 |
| Mobile / Revolving Boards & Glass | 29-30 |
| A-frame Boards, Poster Frame | 31 |
| Easy Rail System | 32 |
| Lap Trays | 33 |
| Customized Products | 34-35 |
| Cast Acrylic Planners | 36 |
| Perpetual Year Planners - Magnetic & Glass | 37-38 |
| In/Out Slides & Boards | 39-40 |
| Wooden Frames | 41 |
| Stationery | 42 |

Interactive

| | |
|--|---------|
| Interactive Touch LED Panels | 78 |
| Interactive Whiteboard System - IR Board | 79 |
| Non-reflective Whiteboard | 80 |
| Interactive Stands for LED Panels & IWB | 81 |
| Data Projectors | 82 |
| Ceiling Mounting Brackets & Projector Cage | 83 |
| Data Projector Trolley | 84 |
| Data Projector Screens & Keystone Adjusters | 85-88 |
| Laser Pointers | 88 |
| Monitor Clamp Bracket | 89 |
| Tripod - Mini, Econo, Deluxe | 90 |
| Brackets - Tablet, TV & Security Cable | 91 |
| Graphics Tablet Wired | 92 |
| Air-mouse, Wireless Keyboard & Mouse | 93 |
| Speaker Sound Bars | 93-94 |
| Audio Devices | 95-96 |
| Acoustic Panel | 97 |
| Lectern & Wireless Mic | 98 |
| Video Conference Camera, Webcam & Microphone | 99-100 |
| Wireless Presentation | 101 |
| Visualizers | 101 |
| External Storage | 102 |
| Cables & Adaptors | 103 |
| LED Modular Display | 104-105 |

Accessories

| | |
|---|---|
| Vinyl Lettering / Vinyl Lining Tape & Magnetic Sheeting | 4 |
| Magnetic Ruler ACP | 4 |
| Flexible Magnetic Accessories | 4 |
| Magnetic Photo Paper & Tape | 4 |
| Moulded Magnets, Extra Strong | 4 |
| Magnetic Map Pins & Magnetic Label Carriers | 4 |
| Drawing Pins & Push Pins | 4 |
| Dusters, Erasers & Aqua Wipe | 4 |
| Pen and Eraser Holder Magnetic | 4 |
| Office Equipment & Whiteboard Cleaner | 4 |
| Whiteboard Starter Packs | 4 |
| Chalk & Chalk Holder | 4 |
| Whiteboard Markers - Bullet Tip | 4 |
| - Slimline Tip | 4 |
| Permanent Markers - Bullet Tip | 5 |
| - Chisel Tip | 5 |
| - Ultra Finesline | 5 |
| Whiteboard Marker Magnetic / Eraser | 5 |
| Glass Board Markers | 5 |
| Highlighter Markers - Chisel Tip, Slimline & Liquid Ink | 5 |

Displays

| | |
|---|---------|
| Poster Frames & Security Frame | 106-107 |
| Media Cover, DBL Sided Window Frame | 108 |
| Poster Frame Support | 109 |
| Poster Frame Stands - Double-sided, Single-sided | 110-111 |
| Poster Frame - Hanging Systems | 112 |
| Flush Wall Signs | 113-114 |
| Double Sided Standing Signs | 115 |
| Double-Sided Wall Signs | 116 |
| Landscape & Portrait Desk Signs | 116 |
| Safety Signs | 117 |
| Hospital Glass Board | 118 |
| Splashbacks - Kitchen, Glass Wall Art & Bathroom | 119-120 |
| Acrylic Certificate Holders | 121 |
| Acrylic Display Holders | 122-123 |
| Designer Mounting Systems - Ceiling & Floor Systems | 124 |
| - Modular Mounting System | 125-126 |
| - Glass Cube Display Stand | 127 |
| Retractable Q-Barrier System | 128 |

Office Equipment

| | |
|--|---------|
| Shredders - S100, S1006S, S200, S1008CC, S1012CC | 54 - 55 |
| Shredders - S516, S1024CC, S1008MC | 56 |
| Shredders - S605, S801 & Shredder oil | 57 |
| Shredder Comparisons | 58 |
| Comb Binding Machines | 59-60 |
| Craft Knives & Rotary Blades | 61 |
| Guillotines - Plastic, Steel Base & Medium Duty | 62-63 |
| Rotary Trimmers | 64-65 |
| Laminators | 66 |
| Laminator Consumables | 67 |
| Staplers, Staples & Staple Remover | 68-73 |
| Punches | 74-75 |
| Carpet Protectors | 76 |
| Megaphone | 77 |

Janitorial

| | |
|--|---------|
| Janitorial Foot Dispensers | 129 |
| Sanitizers | 130 |
| Chemical Range | 131 |
| Refillable Bottles, Refuse bags, Touchless bin | 132 |
| Dispensers | 133 |
| Janitorial Accessories | 134-135 |
| Microfibre Cloths & Bubble Wrap | 136 |

Due to continuous improvement products may be subject to change without notice.

Slimline Whiteboards

Magnetic & Non Magnetic

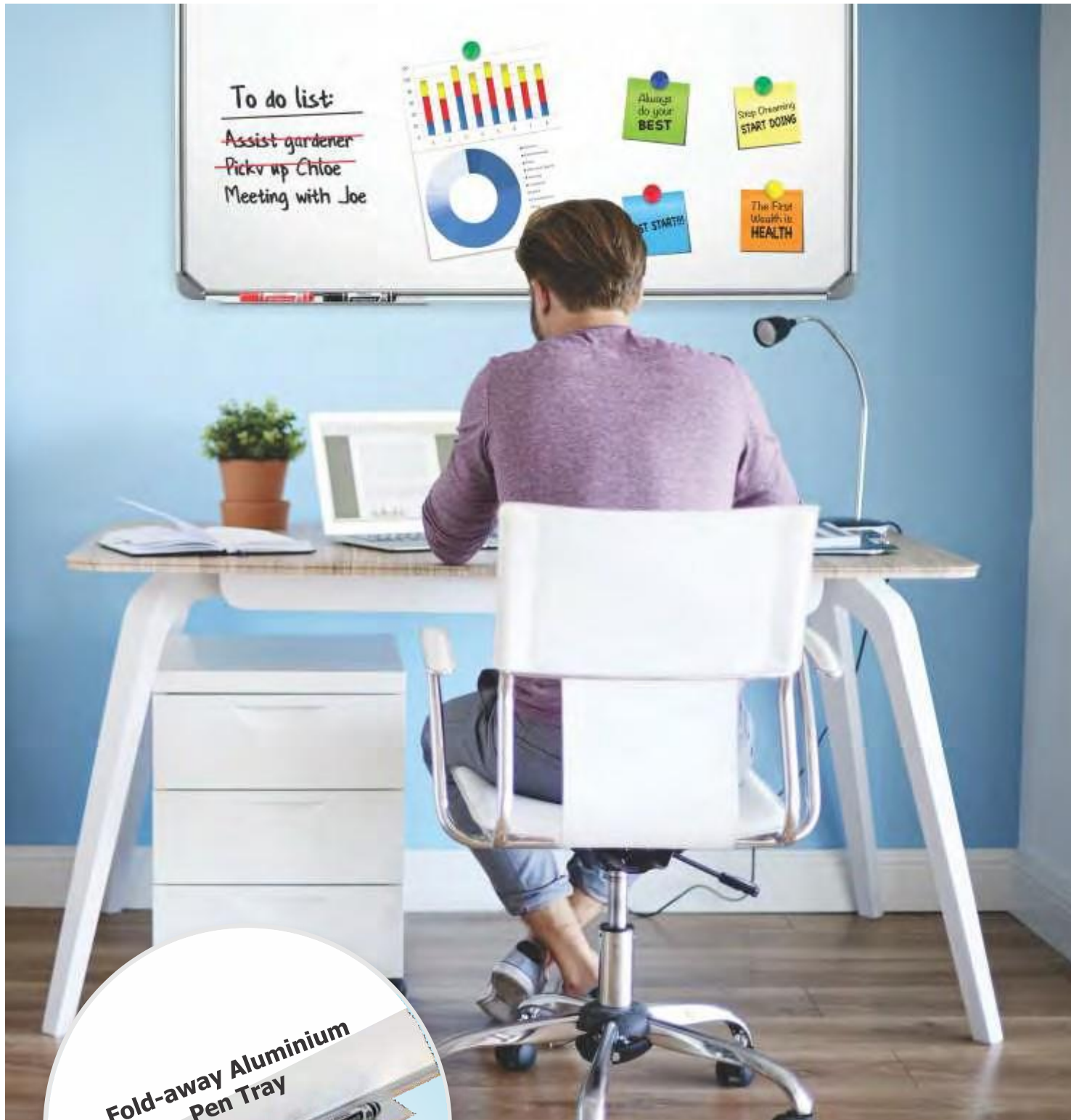

Slimline Whiteboard Retail Pack - Non-Magnetic

| Code | Size |
|----------|-------------|
| BD1520A* | 600 x 450mm |
| BD1525A | 900 x 600mm |

- **BD1520A includes:**
 - 1 Whiteboard Marker
 - 1 Whiteboard Non-Magnetic Eraser
- **BD1525A includes:**
 - 28ml Office Equipment & Whiteboard Cleaner
 - 2 Whiteboard Markers
 - 1 Whiteboard Non-Magnetic Eraser

* Plastic moulded frame on 600 x 450mm Slimline Retail Whiteboards 2 sides

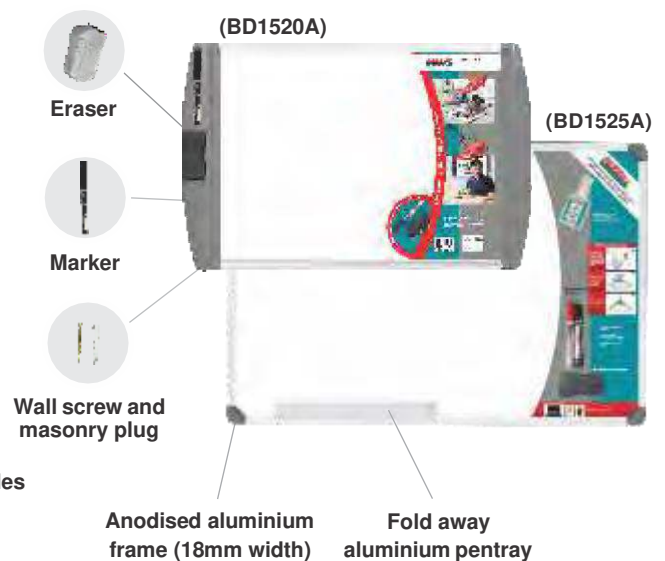

Slimline Whiteboard Retail Pack - Magnetic

| Code | Size |
|----------|--------------|
| BD1120A* | 600 x 450mm |
| BD1125A | 900 x 600mm |
| BD1141A | 1200 x 900mm |

- **BD1120A Magnetic includes:**
 - 4 Moulded Magnets (20mm)
 - 1 Whiteboard Marker
 - 1 Whiteboard Non-Magnetic Eraser
- **BD1125A & BD1141A includes:**
 - 4 Moulded Magnets (20mm)
 - 28ml Office Equipment & Whiteboard Cleaner
 - 2 Whiteboard Markers
 - 1 Whiteboard Non-Magnetic Eraser

* Plastic moulded frame on 600 x 450mm Slimline Retail Whiteboards 2 sides

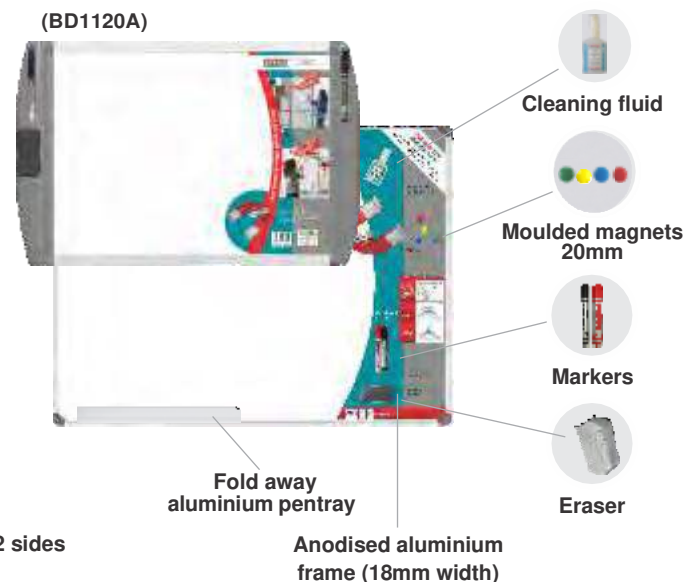

Whiteboard Slimline - Magnetic & Non-Magnetic

| Code | Description | Size |
|---------|--------------|--------------|
| BD1115* | Magnetic | 300 x 450mm |
| BD1120 | Magnetic | 600 x 450mm |
| BD1125 | Magnetic | 900 x 600mm |
| BD1128 | Magnetic | 900 x 900mm |
| BD1141 | Magnetic | 1200 x 900mm |
| BD1515* | Non-Magnetic | 300 x 450mm |
| BD1520 | Non-Magnetic | 600 x 450mm |
| BD1525 | Non-Magnetic | 900 x 600mm |
| BD1528 | Non-Magnetic | 900 x 900mm |
| BD1541 | Non-Magnetic | 1200 x 900mm |

- Includes mounting instructions.
- Concealed mounting (wall screws and masonry plugs supplied, 6mm).
- 18mm frame width

* Supplied with double-sided tape.

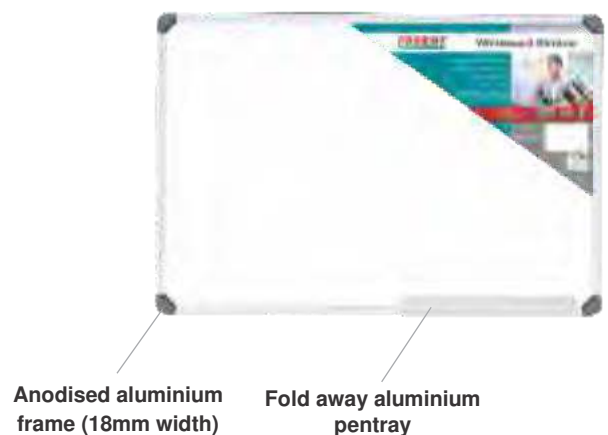

Whiteboards

Non-Magnetic



Code

Size

| | |
|--------|---------------|
| BD1220 | 600 x 450mm |
| BD1225 | 900 x 600mm |
| BD1228 | 900 x 900mm |
| BD1241 | 1200 x 900mm |
| BD1244 | 1000 x 1000mm |
| BD1248 | 1200 x 1000mm |
| BD1252 | 1200 x 1200mm |
| BD1260 | 1500 x 1200mm |
| BD1261 | 1500 x 900mm |
| BD1268 | 1800 x 1200mm |
| BD1269 | 1800 x 900mm |
| BD1270 | 2000 x 1200mm |
| BD1276 | 2400 x 1200mm |

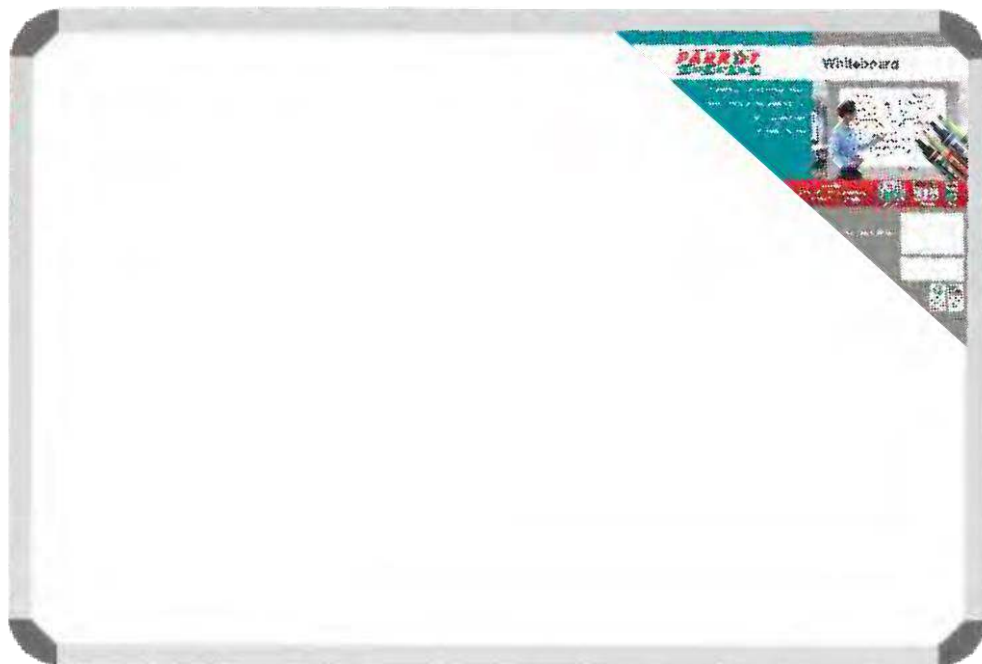

- Can be mounted horizontally or vertically
- Includes Mounting instructions
- Supplied with pentray and concealed mounting (wall screws and masonry plugs, 6mm)
- Can be used with the Easy Rail System (see page 32)
- Can be mounted on T-legs



Boards larger than 1500 x 1200mm are supplied with two 450 x 35mm pentrays.

Pricing for full length pentrays available on request

Note: 3000 x 1200mm Whiteboard available in Magnetic only

Whiteboards

Magnetic



| Code | Size |
|--------|---------------|
| BD0920 | 600 x 450mm |
| BD0925 | 900 x 600mm |
| BD0928 | 900 x 900mm |
| BD0941 | 1200 x 900mm |
| BD0944 | 1000 x 1000mm |
| BD0948 | 1200 x 1000mm |
| BD0952 | 1200 x 1200mm |
| BD0960 | 1500 x 1200mm |
| BD0961 | 1500 x 900mm |
| BD0968 | 1800 x 1200mm |
| BD0969 | 1800 x 900mm |
| BD0970 | 2000 x 1200mm |
| BD0976 | 2400 x 1200mm |
| BD0984 | 3000 x 1200mm |



- Can be mounted horizontally or vertically
- Includes Mounting instructions
- Supplied with pentray and concealed mounting (wall screws and masonry plugs, 6mm)
- Can be used with the Easy Rail System
- Can be mounted on T-legs



Boards larger than 1500 x 1200mm are supplied with two 450 x 35mm pentrays.

Pricing for full length pentrays available on request

Please enquire about boards made to your specifications

Alufine Magnetic Whiteboard

Code Size

| | |
|--------|--------------|
| BD1020 | 600 x 450mm |
| BD1025 | 900 x 600mm |
| BD1041 | 1200 x 900mm |

- Magnetic receptive steel surface
- Sleek and modern anodised 5mm aluminium frame
- No visible frame joins
- Light weight
- Includes mounting tabs
- Can be mounted landscape or portrait
- For home and office use
- Includes PW0101M (Whiteboard Marker with magnetic integrated eraser cap)

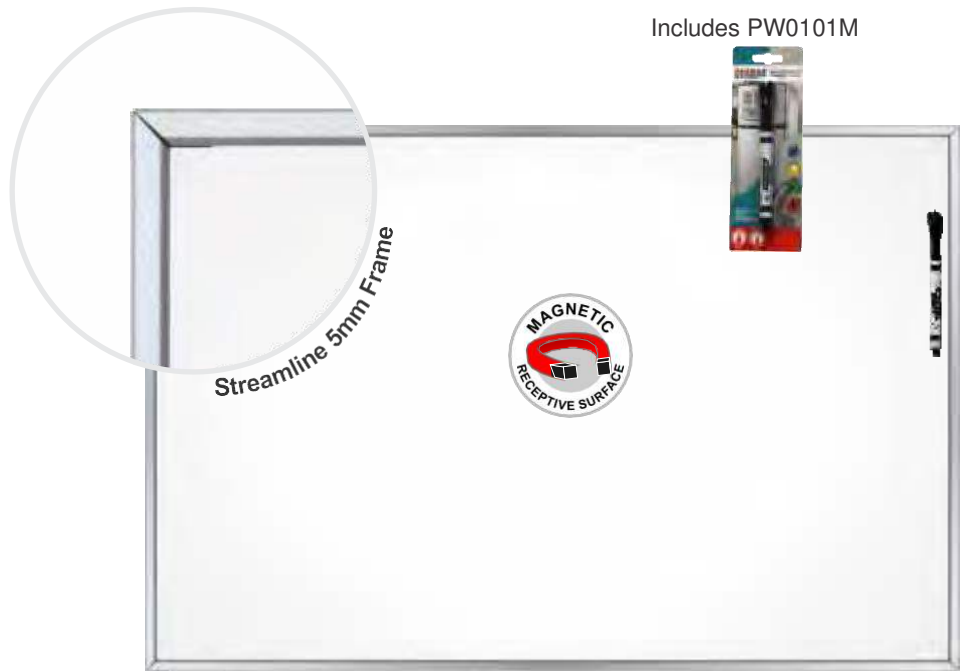

Floating Glass Whiteboard

Magnetic

Code Size

| | |
|--------|---------------------|
| BD2025 | 900 x 600mm x 4mm |
| BD2028 | 900 x 900mm x 4mm |
| BD2041 | 1200 x 900mm x 4mm |
| BD2052 | 1200 x 1200mm x 4mm |
| BD2061 | 1500 x 1200mm x 4mm |
| BD2068 | 1800 x 1200mm x 4mm |
| BD2076 | 2400 x 1200mm x 4mm |

- 2 x aluminium mounting strips
- Magnetic receptive steel surface
- Includes mounting screws & wall plugs
- Tempered glass pentray & stainless steel pentray mounts
- 2 Markers, 1 Eraser & 4 Magnets
- Concealed mounting
- No stand offs
- Sleek frameless design
- Multiple boards can be used to create a glass whiteboard wall
- Perfect for private office and conference rooms



While stocks last

Glass Whiteboards



Includes:
4 Extra Strong
Magnets



Mounting
Brackets



Glass Pen tray

2 Markers
and 1 Eraser

Magnetic

Code Size

| | |
|--------|---------------------|
| BD1725 | 900 x 600mm x 4mm |
| BD1728 | 900 x 900mm x 4mm |
| BD1741 | 1200 x 900mm x 4mm |
| BD1752 | 1200 x 1200mm x 4mm |
| BD1761 | 1500 x 1200mm x 4mm |
| BD1768 | 1800 x 1200mm x 4mm |
| BD1776 | 2400 x 1200mm x 4mm |

Magnetic includes:

- Stainless steel mounting brackets, set of 4
- Tempered glass pen tray & stainless steel pen tray mounts
- 2 Markers, 1 Eraser & 4 Extra Strong Magnets

Non-Magnetic

Code Size

| | |
|--------|---------------------|
| BD1941 | 1200 x 900mm x 4mm |
| BD1952 | 1200 x 1200mm x 4mm |
| BD1961 | 1500 x 1200mm x 4mm |
| BD1968 | 1800 x 1200mm x 4mm |
| BD1976 | 2400 x 1200mm x 4mm |

Non-magnetic includes:

- Stainless steel mounting brackets, set of 4
- Tempered glass pen tray & stainless steel pen tray mounts
- 2 Markers, 1 Eraser

Accessories Re-order Code:

- DM8101A (Mounting edge grips)
- AL3023 (Pen tray) & AL3024 (Pen tray Mounts)



**Only extra strength magnets can be used*

- Superior writing surface
- Cleans perfectly after every use
- Print any graphic, pattern or image
- Aesthetically pleasing alternative to traditional printed whiteboards
- Panels can be mounted landscape or portrait

Printed Glass Whiteboards

Magnetic & Non-magnetic



Printed Glass Whiteboards

Magnetic & Non-magnetic

| Code | Description | Size |
|----------|----------------------|---------------------|
| BD1725A | Magnetic Printed | 900 x 600mm x 4mm |
| BD1728A | Magnetic Printed | 900 x 900mm x 4mm |
| BD1741A | Magnetic Printed | 1200 x 900mm x 4mm |
| BD1752A | Magnetic Printed | 1200 x 1200mm x 4mm |
| BD1761A | Magnetic Printed | 1500 x 1200mm x 4mm |
| BD1768A | Magnetic Printed | 1800 x 1200mm x 4mm |
| BD1776A | Magnetic Printed | 2400 x 1200mm x 4mm |
| BD1941A | Non-Magnetic Printed | 1200 x 900mm x 4mm |
| BD1952A | Non-Magnetic Printed | 1200 x 1200mm x 4mm |
| BD1961A | Non-Magnetic Printed | 1500 x 1200mm x 4mm |
| BD1968A | Non-Magnetic Printed | 1800 x 1200mm x 4mm |
| BD1976A* | Non-Magnetic Printed | 2400 x 1200mm x 4mm |

Magnetic includes:

- Stainless steel mounting brackets, set of 4
- Tempered glass pen tray & stainless steel pen tray mounts
- 2 Markers, 1 Eraser & 4 Extra Strong Magnets

Non-magnetic includes:

- Stainless steel mounting brackets, set of 4
- Tempered glass pen tray & stainless steel pen tray mounts
- 2 Markers & 1 Eraser

- Superior writing surface
- Cleans perfectly after every use
- Print any graphic, pattern or image
- Aesthetically pleasing alternative to traditional printed whiteboards
- Panels can be mounted landscape or portrait
- Customised graphics glass boards are made to order
Subject to glass availability or stock size
- Design fee will apply if artwork is not supplied in vector format, for example: *.ai, *.pdf, *.eps or *.cdr



Solid colours with or without branding

* 2400 x 1200mm is supplied with 8 mounting brackets

Standard Colour Range

*Metallic Colours will incur an additional cost ***

Solid Colour Magnetic Glass Boards include: Stainless steel mountings and a tempered glass pen tray.

| | | | | | | | | | |
|---------------------------------------|---------------------------------------|---|-------------------------------------|--|---|--|--------------------------------------|---|---|
| Colour : Telegrey 4 Code : PT149 | Colour : Purple Red Code : PT150 | Colour : Signal Grey Code : PT151 | Colour : Mouse Grey Code : PT152 | Colour : Papyrus White Code : PT153 | Colour : Grey Blue Code : PT154 | Colour : Pastel Blue Code : PT155 | Colour : Pigeon Blue Code : PT156 | Colour : Charcoal Gun Metal Code : PT157 | Colour : Ocean Blue Code : PT158 |
| Colour : Reseda Green Code : PT159 | Colour : Pastel Green Code : PT160 | Colour : Pastel Turquoise Code : PT161 | Colour : White Code : PT162 | Colour : Beige Code : PT163 | Colour : Metallic Champagne Code : PT164 | Colour : Metallic Silver Code : PT165 | Colour : Rose Gold Code : PT166 | Colour : Metallic Gun Metal Code : PT167 | Colour : Metallic Black Code : PT168 |

Colours can vary when printed on glass due to their refractory properties as well as the pureness of the clear glass.

Chalk Boards

Non Magnetic & Magnetic



Non-Magnetic
Specially-coated MDF board and is the best value for money



Magnetic
Specially-coated steel, high quality surface which is the most popular option for schools and offices



Non-Magnetic

| Code | Size |
|--------|---------------|
| BD2820 | 600 x 450mm |
| BD2825 | 900 x 600mm |
| BD2828 | 900 x 900mm |
| BD2841 | 1200 x 900mm |
| BD2844 | 1000 x 1000mm |
| BD2848 | 1200 x 1000mm |
| BD2852 | 1200 x 1200mm |
| BD2860 | 1500 x 1200mm |
| BD2861 | 1500 x 900mm |
| BD2868 | 1800 x 1200mm |
| BD2869 | 1800 x 900mm |
| BD2870 | 2000 x 1200mm |
| BD2876 | 2400 x 1200mm |



Magnetic

| Code | Size |
|--------|---------------|
| BD2720 | 600 x 450mm |
| BD2725 | 900 x 600mm |
| BD2728 | 900 x 900mm |
| BD2741 | 1200 x 900mm |
| BD2744 | 1000 x 1000mm |
| BD2748 | 1200 x 1000mm |
| BD2752 | 1200 x 1200mm |
| BD2760 | 1500 x 1200mm |
| BD2761 | 1500 x 900mm |
| BD2768 | 1800 x 1200mm |
| BD2769 | 1800 x 900mm |
| BD2770 | 2000 x 1200mm |
| BD2776 | 2400 x 1200mm |
| BD2784 | 3000 x 1200mm |



* 3000mm
Supplied in magnetic only

Product Features

- Concealed mounting (wall screws and masonry plugs supplied, 6mm)
- Slide-in aluminium Chalk Rail (450 x 35mm)
- Additional mounting brackets for boards larger than 1500mm
- Can be used with the Easy Rail System
- Can be used with T-leg stand

See page 48 for Chalk & Chalk Holders

Educational Boards

Embedded Grid Surface Print



Each board is ordered separately to create a complete solution.

Sections to be ordered separately: A) Side Panels, B) Swing Leafs, C) Centre Panel

A Educational Board Side Panel 1220 x 920mm

Code Description

ED1268A Whiteboard Magnetic Grey Squares
ED3268A Chalk Board Magnetic Grey Squares

B Educational Board Swing Leaf 1220 x 910mm

Code Description

ED4168A Whiteboard Magnetic Grey Squares one side
ED6268A Chalk Board Magnetic Grey Squares one side

C Educational Board Centre Panel 1820 x 1220mm

Code Description

ED7068 Whiteboard Magnetic
ED8068 Chalk Board Magnetic
ED9068 Chalk Board Non-Magnetic
AL0320 Hinge Plastic Grey & Aluminium Mounting (each)
AL0330 Steel Hinge (each)

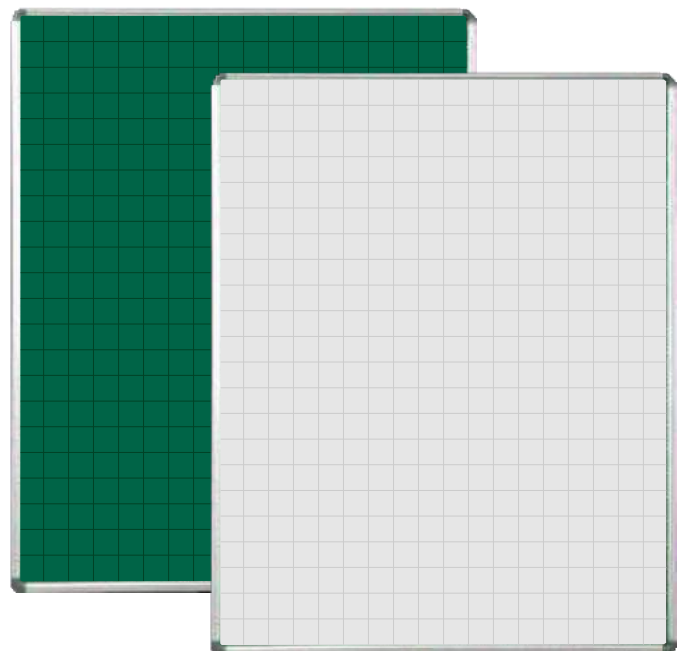

- A modern alternative to the existing Parrot Edu Board Range
- Cost effective, high quality educational board
- Magnetic receptive steel surface
- Light grey embedded grid print on either White or Green surface
- Feint grid is unobtrusive and allows for presentation with or without use of grid
- Grid serves dual purpose of lines and/or grid
- Supplied with pentray, mounting screws and plugs
- Grid size: 50 x 50mm

Benefits of new surface:

Shorter lead time on larger quantities

Made to order in centre panels and double sided swing leaves



Deluxe Frame



AL0320 Heavy Duty Hinges



Corner Buffers



AL0330 Steel Hinge Available on request

Educational Boards

CKS 36: 2004 Compliant

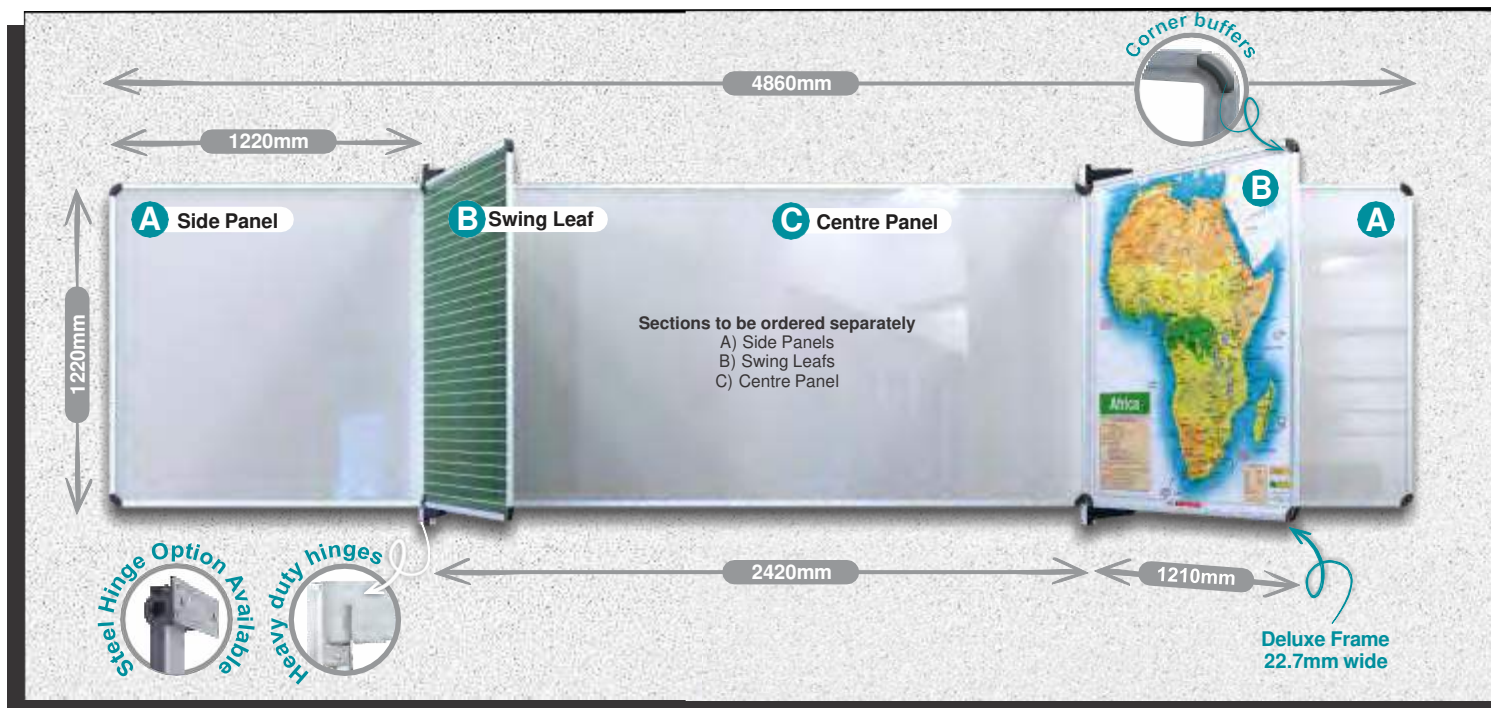

A Educational Board Side Panel 1220 x 1220mm

Code Description

| | |
|--------|--|
| ED1052 | Whiteboard Magnetic |
| ED1152 | Whiteboard Magnetic <i>Lines 50mm</i> |
| ED1252 | Whiteboard Magnetic <i>Squares 50 x 50mm</i> |
| ED2052 | Chalk Board Magnetic |
| ED3052 | Chalk Board Non-Magnetic |
| ED3152 | Chalk Board Non-Magnetic, <i>Lines 50mm</i> |
| ED3252 | Chalk Board Non-Magnetic, <i>Squares 50 x 50mm</i> |
| GB1052 | Whiteboard Magnetic Music Lines |
| GB2052 | Whiteboard Magnetic South Africa Map |
| GB3052 | Whiteboard Magnetic Africa Map |

Code Description

| | |
|--------|--|
| ED6052 | Chalk Board Non-Magnetic |
| ED6152 | Chalk Board Non-Magnetic <i>Lines 50mm one side</i> |
| ED6252 | Chalk Board Non-Magnetic <i>Squares 50 x 50mm one side</i> |
| ED6352 | Chalk Board Non-Magnetic <i>Lines 50mm / Squares 50 x 50mm</i> |

B Educational Board Swing Leaf 1220 x 1210mm

Code Description

| | |
|--------|---|
| ED4052 | Whiteboard Magnetic |
| ED4152 | Whiteboard Magnetic <i>Lines 50mm one side</i> |
| ED4252 | Whiteboard Magnetic <i>Squares 50 x 50mm one side</i> |
| ED4352 | Whiteboard Magnetic <i>Lines 50mm / Squares 50 x 50mm</i> |
| ED5052 | Chalk Board Magnetic |

C Educational Board Centre Panel 2420 x 1220mm

Code Description

| | |
|--------|--|
| ED7076 | Whiteboard Magnetic |
| ED8076 | Chalk Board Magnetic |
| ED9076 | Chalk Board Non-Magnetic |
| ED9176 | Chalk Board Non-Magnetic <i>Lines</i> |
| AL0320 | Hinge Plastic Grey & Aluminium Mounting (each) |
| AL0330 | Steel Hinge (each) |

- Heavy-duty plastic hinges, Steel hinge option available • Aluminium frame.
- Centre panel fitted with an aluminium Chalk Rail / Pentray.
- Double-sided swing-leaf panels. • Deluxe frame 22.7mm wide • Includes mounting instructions.

• Available in 7 writing surfaces:

- Magnetic & Non-Magnetic Whiteboard.
- Magnetic & Non-Magnetic Chalkboard.
- Lines & Grids (on Magnetic Whiteboard and Non-Magnetic Chalk Board surfaces only).
- Maps & Music Lines (on Magnetic Whiteboard surface only).



- All boards comply to Standards South Africa in terms of CKS 36:2004 Edition 4. As approved by the Department of Trade and Industry in April 2004.

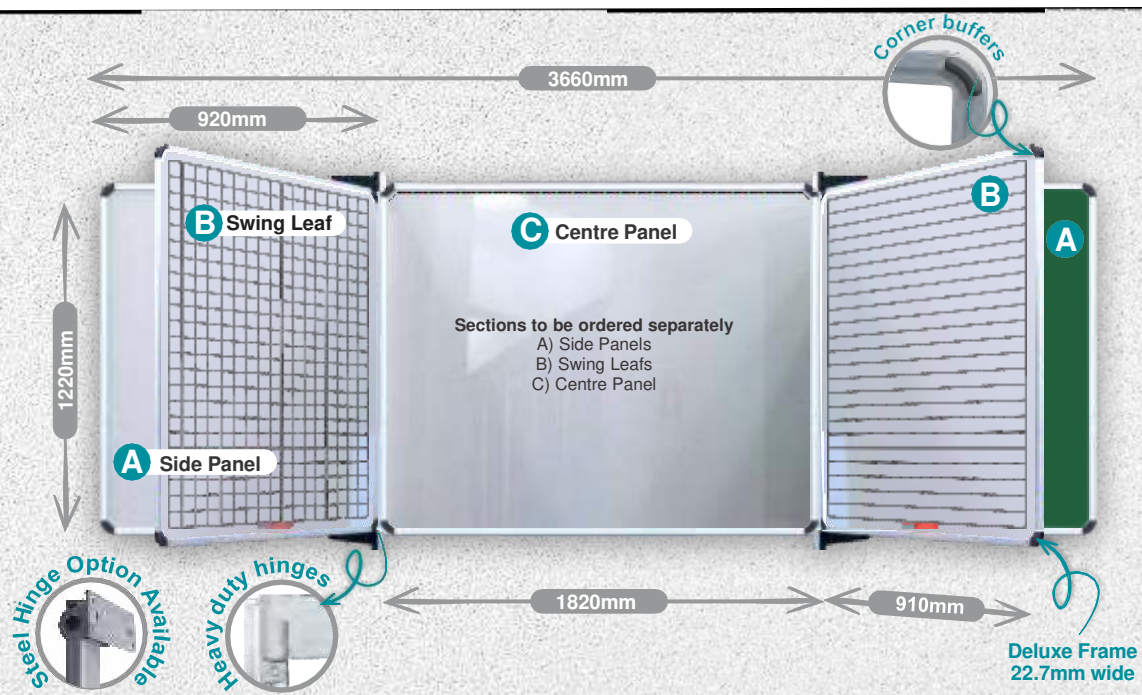

A Educational Board Side Panel 1220 x 920mm

Code Description

| | |
|--------|--|
| ED1068 | Whiteboard Magnetic |
| ED1168 | Whiteboard Magnetic <i>Lines 50mm</i> |
| ED1268 | Whiteboard Magnetic <i>Squares 50 x 50mm</i> |
| ED2068 | Chalk Board Magnetic |
| ED3068 | Chalk Board Non-Magnetic |
| ED3168 | Chalk Board Non-Magnetic, <i>Lines 50mm</i> |
| ED3268 | Chalk Board Non-Magnetic, <i>Squares 50 x 50mm</i> |
| GB3068 | Whiteboard Magnetic Africa Map |

B Educational Board Swing Leaf 1220 x 910mm

Code Description

| | |
|--------|---|
| ED4068 | Whiteboard Magnetic |
| ED4168 | Whiteboard Magnetic <i>Lines 50mm one side</i> |
| ED4268 | Whiteboard Magnetic <i>Squares 50 x 50mm one side</i> |
| ED4368 | Whiteboard Magnetic <i>Lines 50mm / Squares 50 x 50mm</i> |
| ED5068 | Chalk Board Magnetic |
| ED6068 | Chalk Board Non-Magnetic |

Code Description

| | |
|--------|--|
| ED6168 | Chalk Board Non-Magnetic <i>Lines 50mm one side</i> |
| ED6268 | Chalk Board Non-Magnetic <i>Squares 50 x 50mm one side</i> |
| ED6368 | Chalk Board Non-Magnetic <i>Lines 50mm / Squares 50 x 50mm</i> |

C Educational Board Centre Panel 1820 x 1220mm

Code Description

| | |
|--------|--|
| ED7068 | Whiteboard Magnetic |
| ED8068 | Chalk Board Magnetic |
| ED9068 | Chalk Board Non-Magnetic |
| AL0320 | Hinge Plastic Grey & Aluminium Mounting (each) |
| AL0330 | Steel Hinge (each) |



Music Lines
30mm apart inside blocks



Map Africa



Educational Lines
50mm apart



50 x 50mm Squares

See page 48 for Chalk & Chalk Holder



We
install
just about
anywhere

- A friendly & efficient team
- Affordable rates • Installation of any of our product range

☎ 0722593444 ✉ george@gshxpertsolutions.co.za

Installation in Gauteng, Bloemfontein, Durban, Cape Town, Port Elizabeth, Nelspruit & Namibia

Writing Slates

Chalk board, Markerboard & Plastic



Code

Description

Size

| | | |
|---------|--|--------------------|
| BD2802 | Writing Slate Chalk Board Single Sided Carded | 297 x 210 x 3mm |
| BD2802A | Writing Slate Chalk Board Single Sided Uncarded Pack of 10 | 297 x 210 x 3mm |
| BD2805 | Writing Slate Markerboard Chalkboard Double Sided Carded | 297 x 210 x 4mm |
| BD2805A | Writing Slate Markerboard Chalkboard Double Sided Uncarded Pack 10 | 297 x 210 x 4mm |
| BD1002 | Writing Slate Markerboard Single Sided Carded | 297 x 210 x 3mm |
| BD1002A | Writing Slate Markerboard Single Sided Uncarded Pack 10 | 297 x 210 x 3mm |
| BD1003 | Writing Slate Markerboard Single Sided (A3) | 420 x 297 x 3mm |
| BD1003A | Writing Slate Markerboard Single Sided (A3) Uncarded Pack 10 | 420 x 297 x 3mm |
| BD1004B | Writing Slate Plastic Writing Lines | 297 x 210 x 0.75mm |
| BD1004C | Writing Slate Plastic Lines <i>**While stocks last</i> | 297 x 210 x 0.75mm |
| BD1004D | Writing Slate Plastic Music Lines | 297 x 210 x 0.75mm |
| BD1004R | Writing Slate Plastic Retail | 297 x 210 x 0.75mm |

Board Writing Slate Product Features

- Writing Slates are available in double and single-sided, single-carded packs or uncarded packs of ten.

Plastic Writing Slate Product Features

- Permanently printed teaching lines and grids. • Use with Parrot Whiteboard Markers for write and wipe surface.

Writing Slates

Chalk board, Markerboard & Plastic



BD2802



BD1002



BD1003A



BD2805

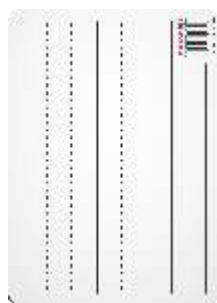

BD1004B



BD1004C



BD1004D



BD1004R

Clipboards

Whiteboard, Masonite & Brushed Aluminium

| Code | Description | Size |
|--------|-------------------------------|-----------------|
| CB3000 | Clipboard Whiteboard | 355 x 230 x 3mm |
| CB3005 | Clipboard Masonite | 355 x 230 x 3mm |
| CB3010 | Clipboard Masonite (A5) | 210 x 147 x 3mm |
| CB3015 | Clipboard - Brushed Aluminium | 355 x 230 x 3mm |

- Clipboard Whiteboard has a Write 'n Wipe surface.
- All Clipboards have a Bulldog clip.

- Customized printing or logo print on whiteboard is available



CB3000

CB3005

CB3015

Writing Slate/Tablet LCD



Reminders & Notes

Practice & Learning

Teaching & Demonstrating

Code Screen Size

BD2810 10inch

- 10" LCD Writing Tablet
- Easy to write
- Easy to erase with the one touch erase button
- Light weight & portable
- Ideal for home and office use
- No electricity required
- Stylus Pen included
- CR2025 battery included



LCD Writing



Erase Button



Child Friendly



Long Lasting Battery

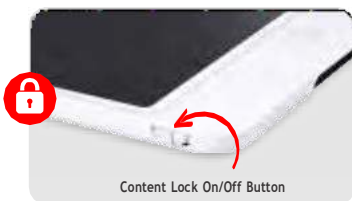

Content Lock On/Off Button



Erase Button

Whiteboard Mini Tiles

Magnetic 355 x 355mm

Code

BD1817B
BD1817G
BD1817P
BD1817W
BD1817S

- Write & Wipe surface
- Ideal for Home & Office use
- 1 Dry Erase Marker
- 1 Wet Erase Marker (BD1817B only)
- 4x Corner Mounting Tape



BD1817B



BD1817G



BD1817P



BD1817W



BD1817S



Available colours - ex stock:

Colour codes: Black(B), Green(G),
Pink(P), White(W), Silver (S)



Flexi Magnetic 240 x 170mm

Code Description

BD1001 Flexi - Magnetic A5

- Whiteboard Marker with magnetic cap & integrated eraser included.
- Perfect to use on fridges or any steel surface.

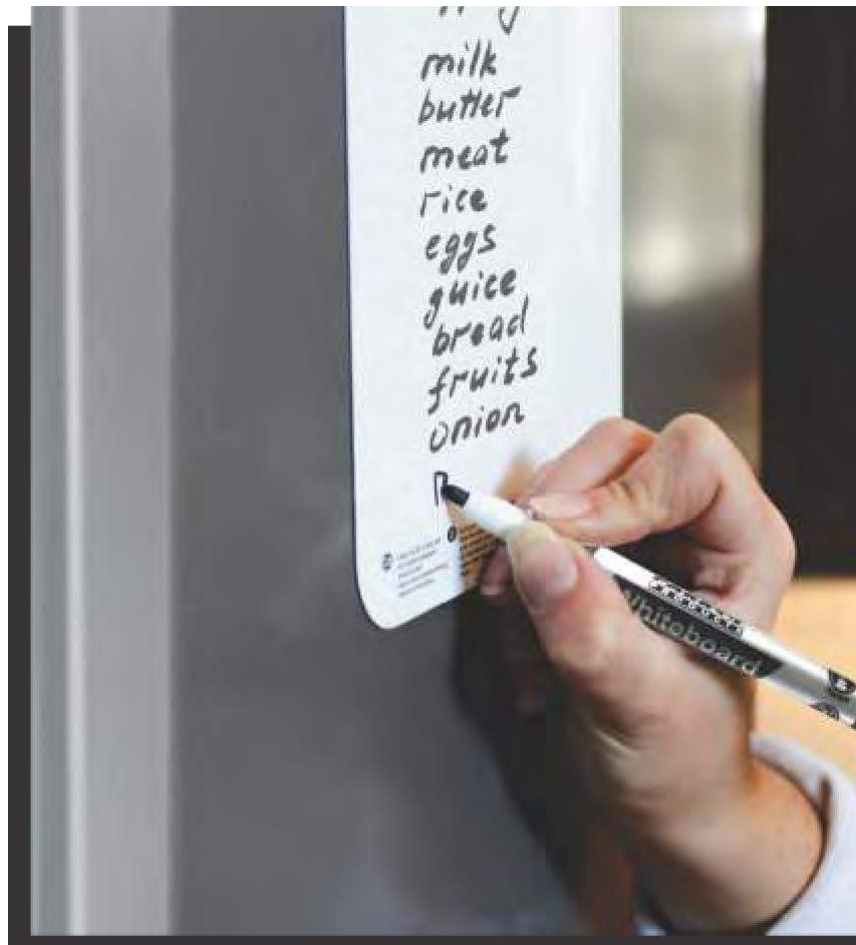

Pin Board

Self Adhesive Backing, No Frame



| Code | Size |
|--------|-------------|
| BD0315 | 450 x 300mm |
| BD0320 | 600 x 450mm |
| BD0325 | 900 x 600mm |

Features:

- Full adhesive backing requires no mounting devices
- Superior pinning surface
- Lightweight
- Frameless
- For home and office use

Includes:

- Adhesive Backing
- 3 x Drawing Pins



Include colour code when ordering

Available felt colours - ex stock:

Colour codes: Black(B), Grey(L), Royal Blue(D), Red(R), Lime(C)



Info Boards

Alufine Frame, Felt

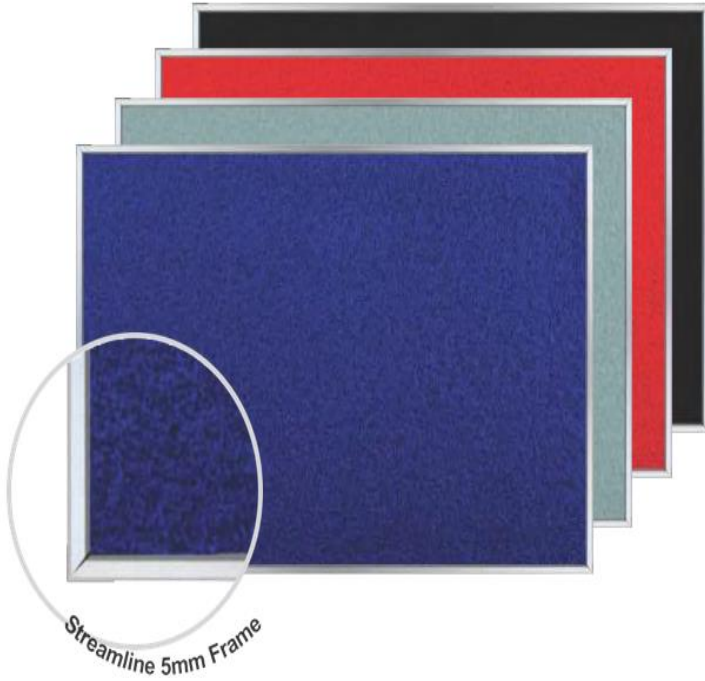

| Code | Size |
|--------|--------------|
| BD0820 | 600 x 450mm |
| BD0825 | 900 x 600mm |
| BD0841 | 1200 x 900mm |

- Felt pinning surface
- Low density pinning surface
- Sleek and modern anodised 5mm aluminium frame
- No visible frame joins
- Light weight
- Includes mounting tabs
- Can be mounted horizontally or vertically
- For home and office use

- Felt dye lots may vary (Lead times apply)

Include colour code when ordering

Available felt colours - ex stock:

Colour codes: Black(B), Grey(L), Royal Blue(D), Red(R)



Include colour code when ordering

Felt colours - made to order (lead times apply)

Colour codes: Lime(C), Purple(A), Orange(O), Sky(S), Beige(F), Pink(P), Yellow(Y), Green(G), Cork (K).



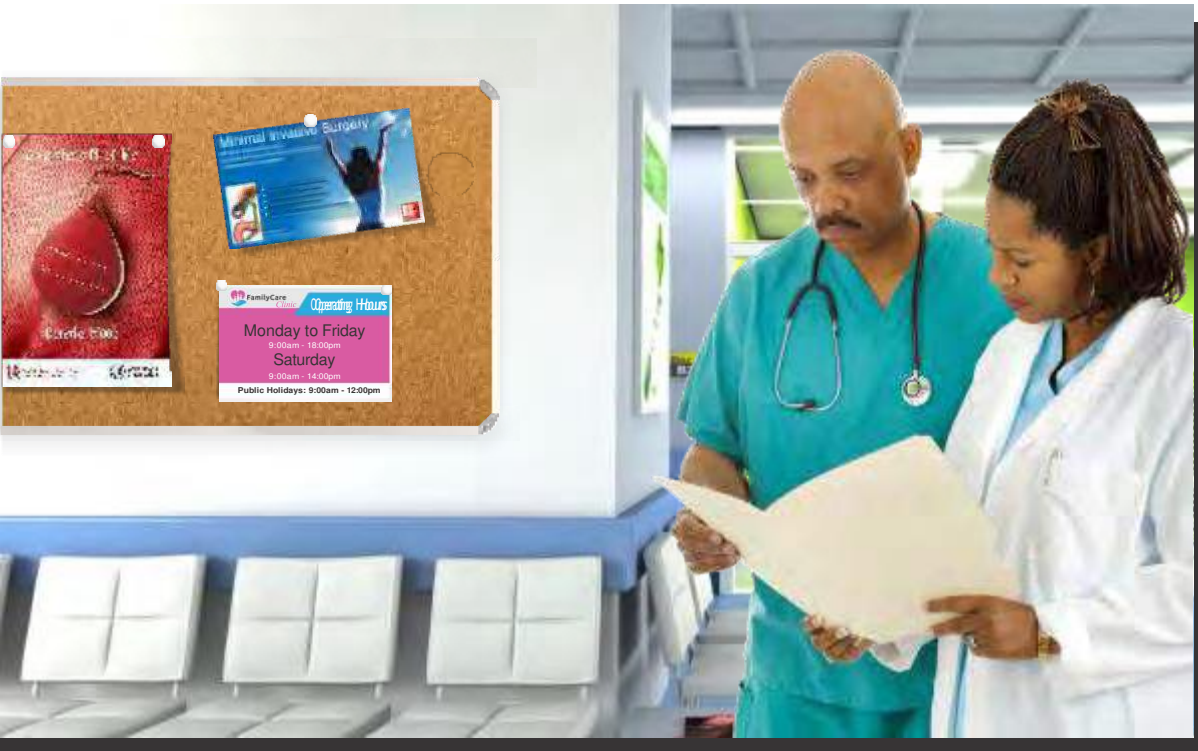

| Code | Size |
|--------|---------------|
| BD0720 | 600 x 450mm |
| BD0725 | 900 x 600mm |
| BD0728 | 900 x 900mm |
| BD0741 | 1200 x 900mm |
| BD0744 | 1000 x 1000mm |
| BD0748 | 1200 x 1000mm |
| BD0752 | 1200 x 1200mm |
| BD0760 | 1500 x 1200mm |
| BD0761 | 1500 x 900mm |
| BD0768 | 1800 x 1200mm |
| BD0769 | 1800 x 900mm |
| BD0770 | 2000 x 1200mm |
| BD0776 | 2400 x 1200mm |
| BD0784 | 3000 x 1200mm |



- Anodised aluminium frame.
- Available in felt or cork pinning surfaces.
- Can be mounted on T-legs

- Felt dye lots may vary
 - Cork surface(K) made to order (aluminium frames only)
 (Lead times apply)

Available felt colours - ex stock:

Colour codes: Black(B), Grey(L), Royal Blue(D), Burgandy(U), Green(G).



Felt colours - made to order (lead times apply)

Colour codes: Lime(C), Purple(A), Orange(O), Sky(S), Beige(F), Pink(P), Yellow(Y), Red(R), Cork (K).



Bulletin Boards

Aluminium Frame, Ribbed Carpet



Code Size

| | |
|--------|---------------|
| BD0620 | 600 x 450mm |
| BD0625 | 900 x 600mm |
| BD0628 | 900 x 900mm |
| BD0641 | 1200 x 900mm |
| BD0644 | 1000 x 1000mm |
| BD0648 | 1200 x 1000mm |
| BD0652 | 1200 x 1200mm |
| BD0660 | 1500 x 1200mm |
| BD0661 | 1500 x 900mm |
| BD0668 | 1800 x 1200mm |
| BD0669 | 1800 x 900mm |
| BD0670 | 2000 x 1200mm |
| BD0676 | 2400 x 1200mm |
| BD0684 | 3000 x 1200mm |

- Anodised aluminium frame.
- Velcro friendly.
- Can be mounted on T-legs

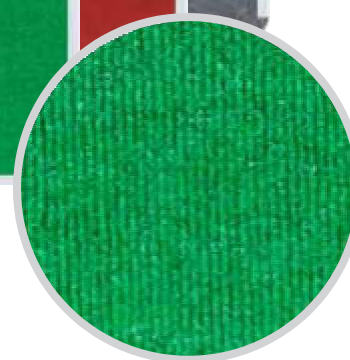
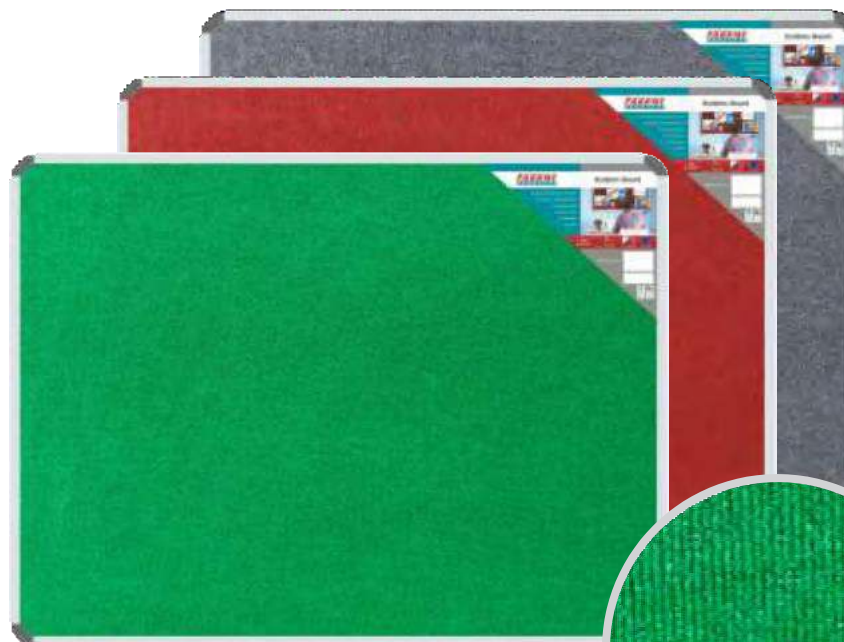

Include colour code when ordering

New ribbed surfaces available colours - ex stock:

Denim(Blue - C), Spice(Beige - Q), Tropical(Maroon - T), Laurel(Grey - X), Palm(Green - Z). - *Dye lots may vary*



Combi Boards

Non-Magnetic



| Code | Size |
|--------|---------------|
| BD3325 | 900 x 600mm |
| BD3041 | 1200 x 900mm |
| BD3070 | 2000 x 1200mm |

- Half Whiteboard & half Pin Board
- Slide-in aluminium pen tray (450 x 35mm).
- Anodised aluminium frame.
- Aluminium H-Bar divider 10mm wide.
- Can be mounted vertically or horizontally.



Include colour code when ordering
Available felt colours - ex stock:
 Colour codes: Black(B), Grey(L), Royal Blue(D), Burgandy(U), Green(G).



Include colour code when ordering
Felt colours - made to order (lead times apply)
 Colour codes: Lime(C), Purple(A), Orange(O), Sky(S), Beige(F), Pink(P), Yellow(Y), Red(R).



Display Cases

Pinning Board



Mounting brackets (wall screws & masonry plugs supplied, 6mm) | Toughened glass - 4mm.
Aluminium frame with reinforced plastic corners | Inside usable depth - 25mm. Outside depth - 60mm.

Hinged Doors

Code **Size**

BD3825 900 x 600mm x 60mm

- Security lock with 2 keys built into doorframe.
- Lockable hinged door. • Packed for retail.
- Can be mounted on T-Legs (T-legs made to order)

Sliding Doors

Code **Size**

BD3841 1200 x 900mm x 60mm

BD3860 1500 x 1200mm x 60mm

- Security lock with 2 keys built into frame.
- Sliding doors.
- 1200 x 900mm display case can be mounted on T-legs. (T-legs made to order)

Sliding glass doors

Hinged doors



Mounting brackets

Security lock with 2 keys

Include colour code when ordering

Available felt colours - ex stock:

Colour codes: Black(B), Grey(L), Royal Blue(D)



Include colour code when ordering

Felt colours - made to order (lead times apply)

Colour codes: Pink(P), Purple(A), Lime(C), Orange(O), Sky(S)

Red(R), Green(G), Beige(F), Burgandy(U)



Flipcharts

Standard Model Non-Magnetic & Magnetic



| Code | Description | Size |
|--------|--------------|--------------|
| BD9131 | Non-Magnetic | 1000 x 640mm |
| BD9132 | Magnetic | 1000 x 640mm |

- Self-adjusting hinge for centre leg
- Max. overall height 1840mm
- In locked position, middle leg can be used as carry handle



Paper clamp

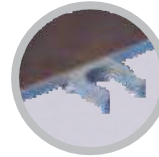

Locking clip at back



Integrated pentray



Self-adjusting hinge



Height adjustable legs



End caps

Standard Model Retail Pack

| Code | Size |
|---------|--------------|
| BD9131A | 1000 x 640mm |

- Self-adjusting hinge for centre leg
- Max. overall height 1840mm
- In locked position, middle leg can be used as carry handle
- Flipchart Non-Magnetic Retail Pack includes: Whiteboard Markers Bullet Tip 10 assorted colours & Flipchart Paper

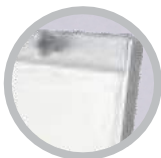

Paper clamp

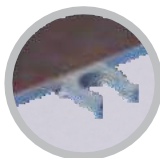

Locking clip at back



Integrated pentray



W/board Markers
Bullet Tip 10 Assorted



Self-adjusting hinge



Height adjustable legs



Flipchart Paper



Flipchart Deluxe Castors



Code Size

BD9145 1000 x 680mm

- Magnetically receptive steel whiteboard surface
- Dry erase surface
- Removable Ruler
- Spring loaded paper gripper
- Integrated folding pentray
- Height adjustable up to 1960mm
- Lockable castors

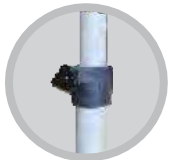

Height adjustable



Spring-loaded Paper Gripper



Clear Ruler Guide



Eraser & Pentray Holder



Lockable castors

Flipchart Glassboards



| Code | Description | Size |
|---------|----------------------------|--------------|
| BD9144 | Flipchart Glass Magnetic | 900 x 1200mm |
| BD9144A | Flipchart Glass Stand Legs | |

- Mobile Flipchart Glassboard for writing with Parrot Markers
- Height Adjustable to 1820mm (overall size)
- Includes Paper Hooks and Pen Tray
- Angle Adjustable
- Frameless Design
- Glass Board size: 900 x 1200mm
- Custom graphics, colour, pattern or image to suit any interior
- Powder coated mild steel stand with lockable castor wheels



Angle adjustable



Paper gripper



Lockable castors



* Refer to page 8 for glass colours

Flipchart Standard Carry Bag

Code **Size**

BA2120 1100 x 680 x 90mm

- Made of durable polyester.
- Holds Standard Flipchart only.



Flipchart Paper Carrier

Code **Size**

BD9341 600mm

- Slides into all standard frame boards.
- Adjustable paper hooks fit all Flipchart Pads.
- For use with Aluminium Frame Boards only (Standard & Deluxe).
- Holds up to 50 sheets.

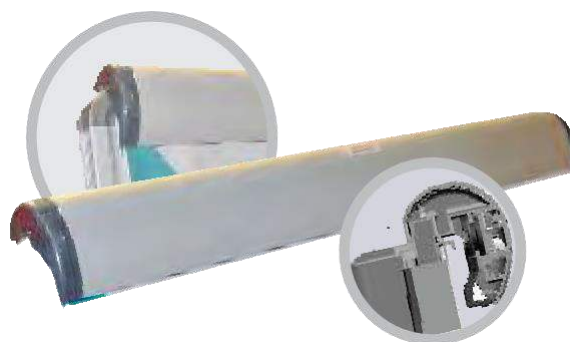

Flipchart Paper

Code **Description**

Size

| | | |
|---------|-------------------------------------|-------------|
| BA2101* | Flipchart Paper Newsprint 50 sheets | 860 x 610mm |
| BA2104* | Flipchart Paper Newsprint 20 sheets | 860 x 610mm |
| BA2102 | Flipchart Paper Bond 50 sheets | 860 x 610mm |
| BA2105 | Flipchart Paper Bond 20 sheets | 860 x 610mm |
| BA2106* | Flipchart Paper Graph 20 sheets | 860 x 610mm |
| BA2107* | Flipchart Paper Rainbow 20 sheets | 860 x 610mm |

*** While stocks last**

- | | |
|---|---|
| <ul style="list-style-type: none"> • Newsprint Pads (45gsm) - 50 Sheets - 20 Sheets | <ul style="list-style-type: none"> • Graph Pads (54gsm) - 20 Sheets - 10 x 10mm squares |
| <ul style="list-style-type: none"> • Bond Pads (60gsm) - 50 Sheets - 20 Sheets | <ul style="list-style-type: none"> • Rainbow Pads (54gsm) - 20 sheets - 5 colours |

- Slotted holes to fit most Flipchart stands.
- Perforated sheets.

**Newsprint
20 sheets**



**Bond
20 sheets**



**Graph
20 sheets**

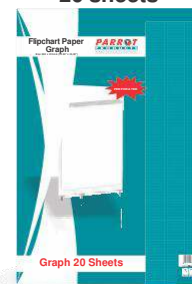

**Newsprint
50 sheets**



**Bond
50 sheets**



**Rainbow
20 sheets**

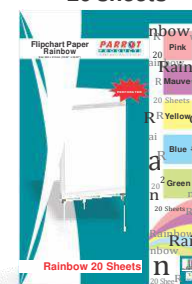

Board Supports

T-Legs

Code Description

| | |
|--------|---|
| BD9010 | T-Leg Set (for Boards up to 1500mm) |
| BD9015 | T-Leg Set (for Boards 1600mm to 2400mm) |

- Lockable and non-lockable castors.
- Horizontal support allows for height adjustment.
- Can be fitted to Standard Frame boards up to 2400mm.

T-legs Set for Boards up to 1500mm

Size: 1400 x 600mm.
Not recommended for boards larger than 1500 x 1200mm.
Board sold separately. No crossbar required.

T-legs Set - Adjustable for Boards 1600mm to 2400mm

Size: 1400 x 600mm.
Not for boards smaller than 1600 x 1200mm.
Board sold separately. Width adjustable crossbar.

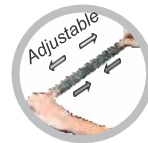

Adjustable width



Horizontal support



Lockable castors

Steel Easel

Code Description

| | |
|--------|------------------------|
| BD9000 | Easel Steel Telescopic |
|--------|------------------------|

- Height-adjustable board supports.
- Telescopic legs.

Folded size: 1060 x 700mm.
Fully extended size: 1000 x 1900mm.
Not recommended for boards larger than 1200 x 1200mm.



Self-adjusting hinge for stability



Board supports

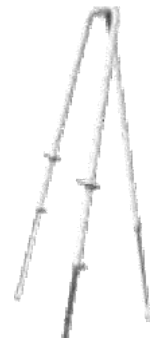

Aluminium Easel

Code Description

| | |
|--------|----------------------------|
| BD9135 | Easel Aluminium Adjustable |
|--------|----------------------------|

- Extends up to 1530mm (H).
- Holds up to 800mm Boards.
- High quality aluminium tube.
- Ideal for studio work.



Board supports



Desk Partition Clamp

Code Description

| | |
|--------|---|
| DC0001 | Desk Partition Clamp |
| DC0002 | Desk Partition Clamp Under Counter Single Sided |
| DC0003 | Desk Partition Clamp Under Counter Double Sided |

- Silver Aluminium Alloy • Desk mounted
- Suitable for panels 3mm up to 16mm (can be used with standard frame whiteboard)
- Spacing: 700mm centre to centre



DC0001



DC0002
Spacing of
25mm



DC0003
Spacing of
25mm

Mobile / Revolving Boards

Magnetic

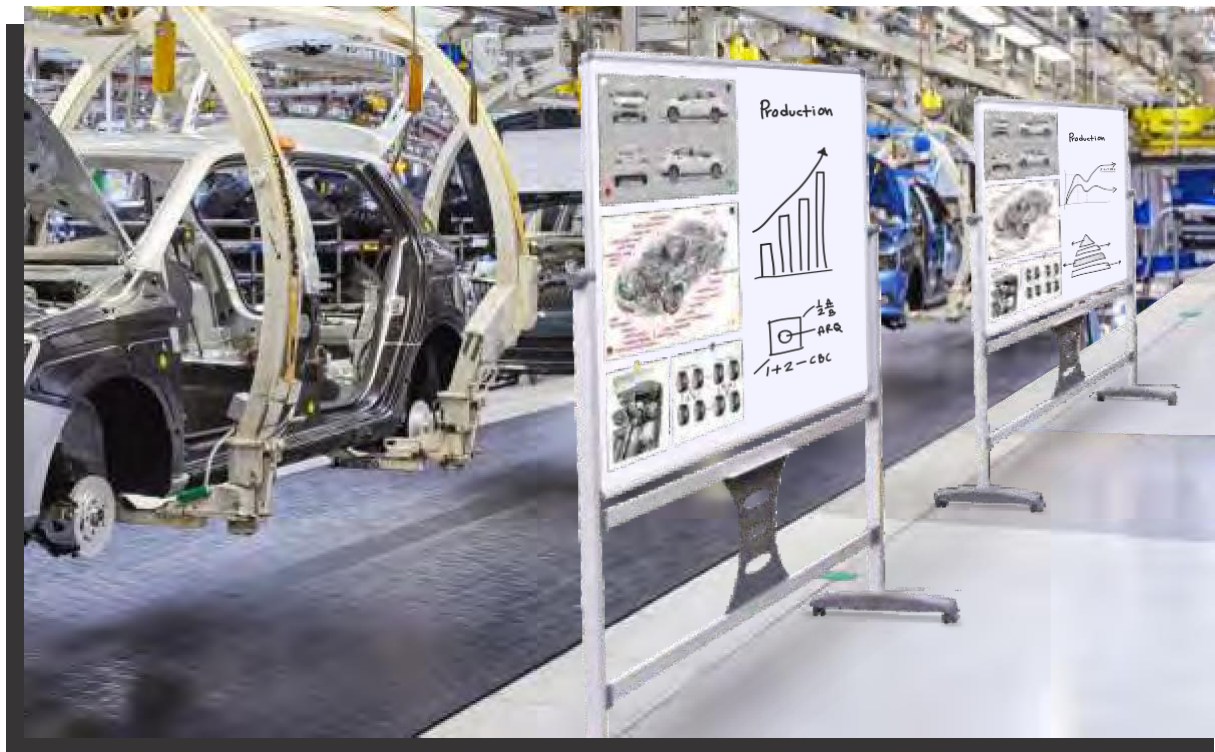

Code Size

| | |
|--------|---------------|
| BD4241 | 1200 x 900mm |
| BD4260 | 1500 x 1200mm |
| BD4261 | 1500 x 900mm |
| BD4268 | 1800 x 1200mm |
| BD4269 | 1800 x 900mm |

- Anodised aluminium frame.
- Double-sided Whiteboard Magnetic.
- Assembles easily without tools.
- Durable and stylish plastic cross bar stabilizer.
- 360° Degrees rotation.



Tightening mechanism to allow rotation

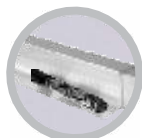

Double-sided pen tray (450mm)



Lockable and non-lockable castors

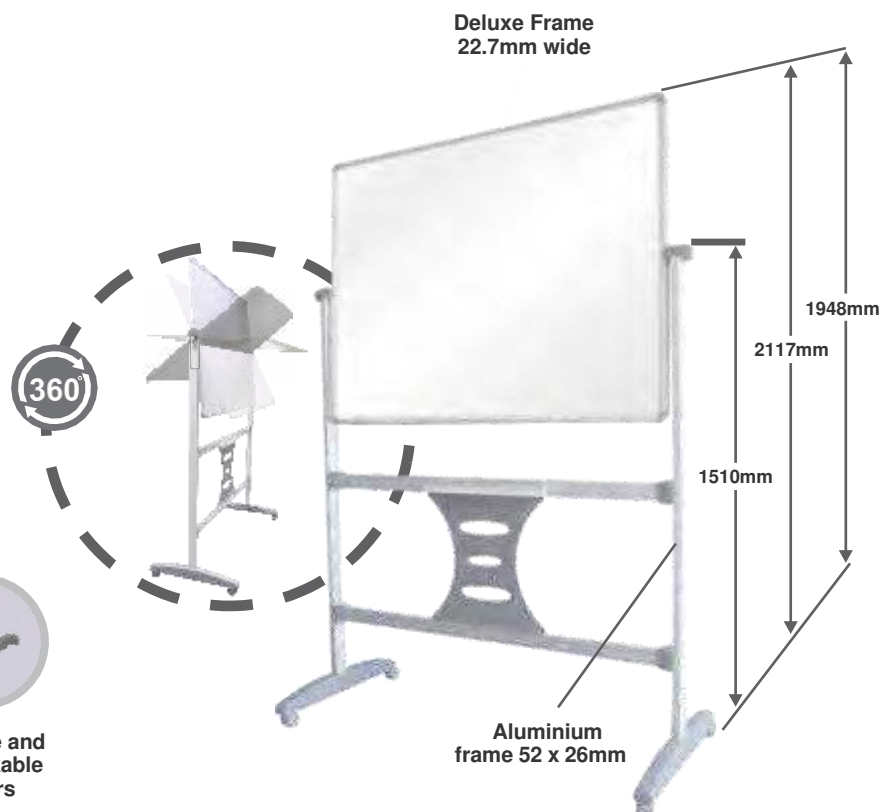

Mobile/Revolving Glass Board

Magnetic Glass - Leg Set



Code Size

BD4270 1200 x 900mm

- Magnetic Surface
- Double-sided pentray (450mm)
- Double-sided Glass Whiteboard
- Double cross bars ensure stability
- Assembles easily without tools
- Durable and stylish plastic crossbar stabilizer
- Will go through a standard door (2100mm diagonally) without disassembling

Can be personalised to any of our solid colour range

- Refer to page 8 for colour range



Tightening mechanism to allow rotation

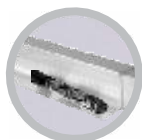

Double-sided Pentray (450mm)



Lockable and Non-lockable Castors



Double layered glass board with pre-drilled holes for assembly of leg set

A-frames

Non-magnetic

| Code | Description | Size |
|--------|------------------------------------|-------------|
| SN0624 | A-Frame Whiteboard Aluminium Frame | 900 x 600mm |
| SN0724 | A-Frame Chalk Board Non-Magnetic | 900 x 600mm |
| SN0824 | A-Frame Whiteboard Non-Magnetic | 900 x 600mm |

SN0624 Features:

- Board locks in stable position.
- Lightweight.
- Standing height of 850mm when open.
- Aluminium framework (25mm).
- Weather resistant.
- Supplied with Whiteboard Marker (Black).

SN0724 & SN0824 Features:

- Board locks in stable position.
- Standing height of 960mm when open.
- Frame 35mm wide.
- Weather resistant.



Powder-coated steel frame 35mm wide



Customized print available

Aluminium framework (25mm)



SN0624

SN0724

SN0824

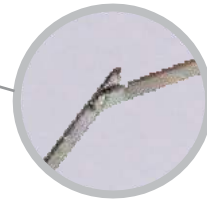

Board locks

Poster A-Frame

| Code | Description | Size |
|--------|---------------------------|--------------|
| BG8100 | A-Frame Poster Frame (A0) | 1250 x 900mm |
| BG8101 | A-Frame Poster Frame (A1) | 900 x 655mm |
| BG8102 | A-Frame Poster Frame (A2) | 655 x 480mm |

- Board locks in stable position.
- Mitred corner.
- Aluminium, spring action frame, 39mm wide.
- Quick and easy display change.
- Non-reflective media cover supplied
- see page 108 for clear media cover options.

Frame 39mm wide



Spring action aluminium frame



Board locks

Code Description

| | |
|--------|--|
| ER0001 | Easy Rail 1 meter |
| ER0002 | Easy Rail 2 meter |
| ER0003 | Easy Rail 3 meter |
| ER0004 | Easy Rail 4 meter |
| ER0005 | Easy Rail 5 meter |
| ER0010 | Easy Rail Mounting Bracket Set Short |
| ER0011 | Easy Rail Mounting Bracket Set Long |
| ER0015 | Easy Rail Connector <i>(for flush mounting of two Easy Rail sections)</i> |

- Double rail system.
- Top brackets with sliders, bottom brackets with wheels.
- Mounting bracket sets supplied with silicone for smooth sliding.
- Double rail system with end stoppers and built-in paper gripper.
- Allows boards to pass in front or behind of one another.
- Largest recommended board size is 1800 x 1200mm.
- Paper Gripper not recommended for laminated paper.
- Fix-screws for mounting are supplied, along with a plastic strip for concealed mounting.

***Boards sold separately**

Top brackets with sliders



Size of Brackets

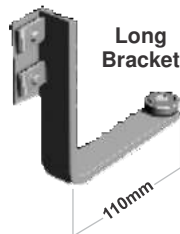

Bottom brackets with wheels

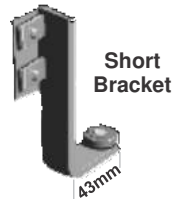

Built-in paper gripper



Multi-Purpose Paper Gripper

| Code | Description | Size |
|---------|----------------------|--------|
| BD9342 | Paper Gripper Retail | 360mm |
| BD9342A | Paper Gripper | 1000mm |
| BD9342B | Paper Gripper | 2000mm |

- Hanging display for paper products
- Ideal for restaurants, offices and classrooms.
- Supplied with masonry screws and double-sided tape.
- Can be installed next to each other for a larger surface area for custom lengths or packed for retail (BD9342).

While stocks last

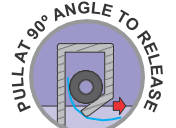
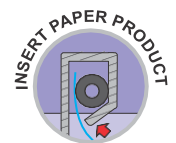

Lap Trays



| Code | Description | Size |
|---------|-------------------------|-------------|
| MI0002 | Lap Tray Tablet - White | 450 x 325mm |
| MI0002A | Lap Tray Tablet - Grey | 450 x 325mm |

- Perfect as a stable surface for writing, reading and surfing the internet in the home or on the go.
- Soft-touch wrist pads provide a layer of comfort
- Also suitable to be used with laptops or cellphones

Available colours:



** Laptop not included*

Products tailored to the specific needs of our customers

Carry your corporate identity through your building with custom made products

Powder Coated Poster Frames



Only applicable to Mitred Corner and Deluxe frames. Colours are available on request, and customization size is max A0.

Signage - Aluminium Sign Frames

Single or double sided including custom print



Add your company logo or design on any of our sign frames.

- Make your statement and stand out from the crowd
- Digital Printing is permanent and will not crack or fade
- Custom made to any size and design

Graphics Boards

Custom Design & Print

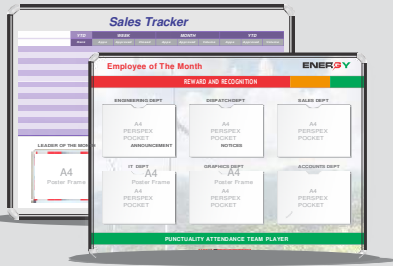

Our graphics boards are made-to-order. We will require you to provide us with your image, design, or our in-house design team can design the artwork at a cost.

Glass Boards

Designed as artistic display or whiteboard



Print any graphic of your choice from the Shutterstock image library or select from our standard 25 solid colour range.

Glass Flipcharts

Full colour or custom print with logo



Select from our standard 25 solid colour range. Provide us with your image or a custom design. Available in magnetic glass board.

Printed Pin Boards

Customized print available



Select from our standard range of felt and carpet stock colours. Customize with your company logo or graphic or provide your design.

Custom Hospital Theatre Glass Boards



Custom print on both Magnetic & Non-magnetic Glass boards. Ideal for hospitals, clinics and medical institutions.

Custom Hospital Glass Boards

Ward - Nurse Station



Available in Magnetic or non-magnetic Custom prints & sizes available on request

*Please note that pricing on customized boards, poster frames and signage is available on request.

Custom Printed Boards



- From shipping movements to menus, hospital plans to information maps, factory and machine schedules. We can produce a unique board incorporating your own design.
- Permanent prints, full colour, with any image, logo or background.
- Includes Starter pack: 2x W/board Markers, Eraser (95 x 55mm), Cleaning Fluid 28ml.

How to order

OPTION 1



You already have print ready artwork

- The artwork must be in vector format, for example: *.ai, *.pdf, *.eps or *.cdr - No design fee will apply
- Forward all relevant artwork information to sales@parrotproducts.biz - No design fee will apply
- Quotation will follow.

OPTION 2



You have a rough idea or sketch of what you'd like

- Contact one of our Key Account Managers or call our National Call Centre on 010 140 4900
- Payment or a company order number for the design fee is required before design process can commence.
- Artwork can be designed in our Graphics Studio. A proof will be sent to you for your approval
- Design fee will apply

OPTION 3



You are unsure of what you need or you have no existing artwork

- Contact one of our Key Account Managers or call our National Call Centre on 010 140 4900
- Payment or a company order number for the design fee is required before design process can commence.
- Artwork can be designed in our Graphics Studio. A proof will be sent to you for your approval
- Design fee will apply

Cast Acrylic Planners

Monthly, Weekly & Yearly Planners 600 x 450mm



Code **Description**

- BD7125 Cast Acrylic Weekly Planner
- BD7126 Cast Acrylic Monthly Planner
- BD7127 Cast Acrylic Yearly Planner

- Slimline Design (3mm thickness)
- Mounted with Double-side tape
- Use with Whiteboard Markers
- Frameless
- Light Weight

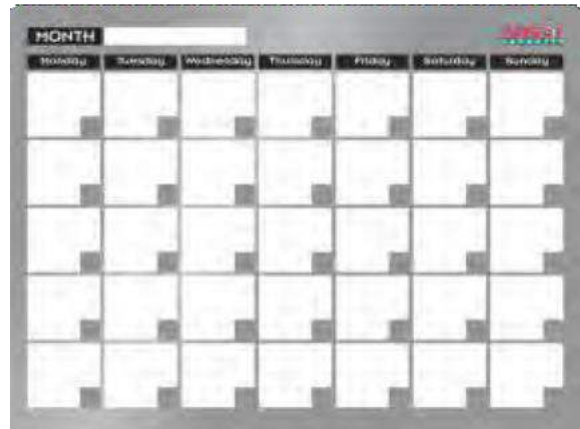

Monthly Planner



Weekly Planner

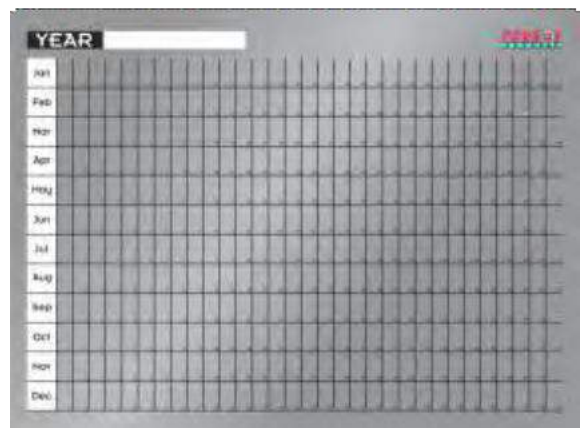

Yearly Planner

Year Planners

Perpetual Year Planner Magnetic



| Code | Description | Size |
|--------|---|---------------|
| BD5140 | Year Planner Magnetic | 1200 x 900mm |
| BD5160 | Year Planner Magnetic | 1500 x 1200mm |
| BD5176 | Year Planner Magnetic | 2400 x 1200mm |
| AL3040 | Date Strips Replacement Kits for 900mm high boards | |
| AL3041 | Date Strips Replacement Kits for 1200mm high boards | |

- Concealed mounting (wall screws and masonry plugs supplied, 6mm).
- Additional mounting brackets for boards larger than 1500mm.
- Slide-in aluminium pentray (450 x 35mm).
- Includes mounting instructions.
- Boards larger than 1500 x 1200mm supplied with 2 pentrays.
- Also supplied with:
Markers, Magnetic Date Strips, Public Holiday Indicators, Planning Shapes & 2 Label Carriers.

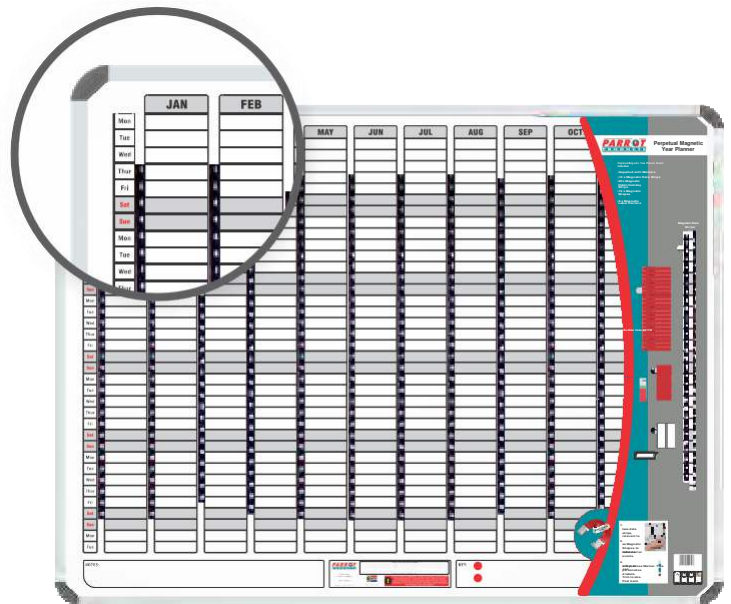

Actual sizes of blocks for each planner

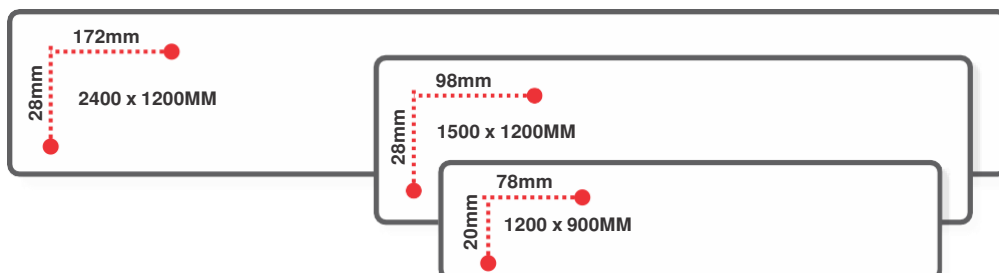

Year Planner

Glass Board Non Magnetic

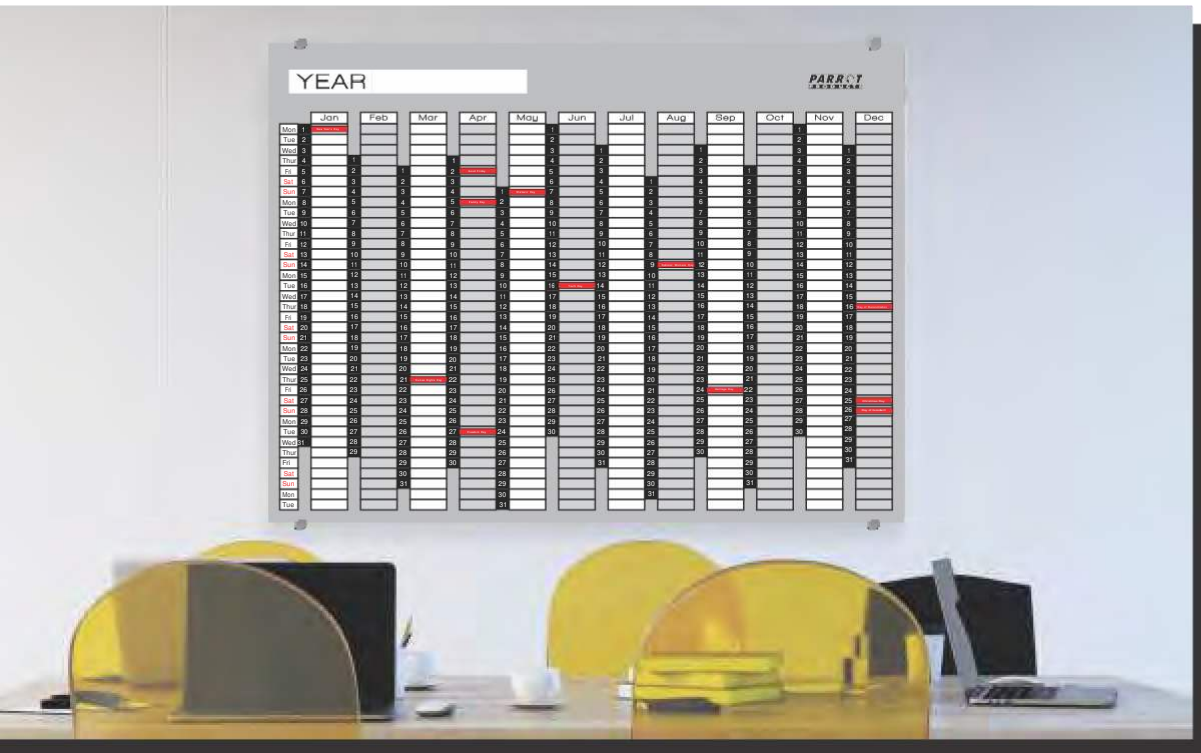

Code **Size**

BD5140G 1200 x 900mm

- Non Magnetic Glass
- Stainless steel mounting brackets (Set of 4 - Re-Order Code: AL3022A)
- For Tempered Glass pentray (Re-Order Code: AL3023)
- Stainless Steel pentray mounts (Re-Order Code: AL3024)

Includes:

- Non Magnetic Glass Whiteboard
- Markers (Red & Black)
- Eraser
- Nano Tape Date strips
- Public Holiday Indicators
- Tempered glass pentray

| YEAR | | | | | | | | | | | | |
|------|-----|-----|-----|-----|-----|-----|-----|-----|-----|-----|-----|-----|
| | Jan | Feb | Mar | Apr | May | Jun | Jul | Aug | Sep | Oct | Nov | Dec |
| Mon | 1 | | | | | 1 | | | | | 1 | |
| Tue | 2 | | | | | 2 | | | | 2 | | 2 |
| Wed | 3 | | | | | 3 | | | | 3 | | 3 |
| Thur | 4 | 1 | | 1 | | 4 | | | 1 | 4 | | 4 |
| Fri | 5 | 2 | 1 | 2 | | 5 | | | 2 | 5 | | 5 |
| Sat | 6 | 3 | 2 | 3 | | 6 | | | 3 | 6 | | 6 |
| Sun | 7 | 4 | 3 | 4 | | 7 | | | 4 | 7 | | 7 |
| Mon | 8 | 5 | 4 | 5 | | 8 | | | 5 | 8 | | 8 |
| Tue | 9 | 6 | 5 | 6 | | 9 | | | 6 | 9 | | 9 |
| Wed | 10 | 7 | 6 | 7 | | 10 | | | 7 | 10 | | 10 |
| Thur | 11 | 8 | 7 | 8 | | 11 | | | 8 | 11 | | 11 |
| Fri | 12 | 9 | 8 | 9 | | 12 | | | 9 | 12 | | 12 |
| Sat | 13 | 10 | 9 | 10 | | 13 | | | 10 | 13 | | 13 |
| Sun | 14 | 11 | 10 | 11 | | 14 | | | 11 | 14 | | 14 |
| Mon | 15 | 12 | 11 | 12 | | 15 | | | 12 | 15 | | 15 |
| Tue | 16 | 13 | 12 | 13 | | 16 | | | 13 | 16 | | 16 |
| Wed | 17 | 14 | 13 | 14 | | 17 | | | 14 | 17 | | 17 |
| Thur | 18 | 15 | 14 | 15 | | 18 | | | 15 | 18 | | 18 |
| Fri | 19 | 16 | 15 | 16 | | 19 | | | 16 | 19 | | 19 |
| Sat | 20 | 17 | 16 | 17 | | 20 | | | 17 | 20 | | 20 |
| Sun | 21 | 18 | 17 | 18 | | 21 | | | 18 | 21 | | 21 |
| Mon | 22 | 19 | 18 | 19 | | 22 | | | 19 | 22 | | 22 |
| Tue | 23 | 20 | 19 | 20 | | 23 | | | 20 | 23 | | 23 |
| Wed | 24 | 21 | 20 | 21 | | 24 | | | 21 | 24 | | 24 |
| Thur | 25 | 22 | 21 | 22 | | 25 | | | 22 | 25 | | 25 |
| Fri | 26 | 23 | 22 | 23 | | 26 | | | 23 | 26 | | 26 |
| Sat | 27 | 24 | 23 | 24 | | 27 | | | 24 | 27 | | 27 |
| Sun | 28 | 25 | 24 | 25 | | 28 | | | 25 | 28 | | 28 |
| Mon | 29 | 26 | 25 | 26 | | 29 | | | 26 | 29 | | 29 |
| Tue | 30 | 27 | 26 | 27 | | 30 | | | 27 | 30 | | 30 |
| Wed | 31 | 28 | 27 | 28 | | 31 | | | 28 | 31 | | 31 |
| Thur | | 29 | 28 | 29 | | | | | 29 | | | |
| Fri | | 30 | 29 | 30 | | | | | 30 | | | |
| Sat | | 31 | | | | | | | 31 | | | |
| Sun | | | | | | | | | | | | |
| Mon | | | | | | | | | | | | |
| Tue | | | | | | | | | | | | |

In/Out Slides

Surface Mounted In/Out Slides



| Code | Description | Size |
|---------|--|------------|
| BD4110 | In / Out Slide Box of 10 | 400 x 50mm |
| SN1003A | Sign Frame In/Out Slide Printable Sticker | 38 x 99mm |

- The printable stickers can be used for the Parrot In / Out Slide Sign frame.
- Print the name on Self-adhesive Labels provided.
(To be used with laser printers only)
- 2 sheets of Self-adhesive Labels
- 14 stickers per sheet
- White colour stickers
- Each label size is 38 x 99mm

Packed for Retail

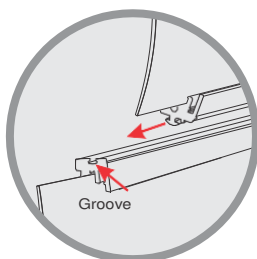

For Personalised Surface Mounted In / Out Slides contact our Call Centre

| NAME | IN/OUT | RETURNING | MESSAGES |
|-----------|--------|-----------|--------------------|
| Mark V | IN | | |
| Thabo M | IN | 4pm | Presentation / MVP |
| Robin | IN | | |
| Mr Errol | IN | 12pm | Client Meeting |
| Cassidy | IN | 11:30 | Client Meeting |
| Benjamin | IN | 3pm | Trade Show |
| Jake | IN | | |
| Cyril | IN | | |
| Whitney | IN | | |
| Siphokasi | IN | | |

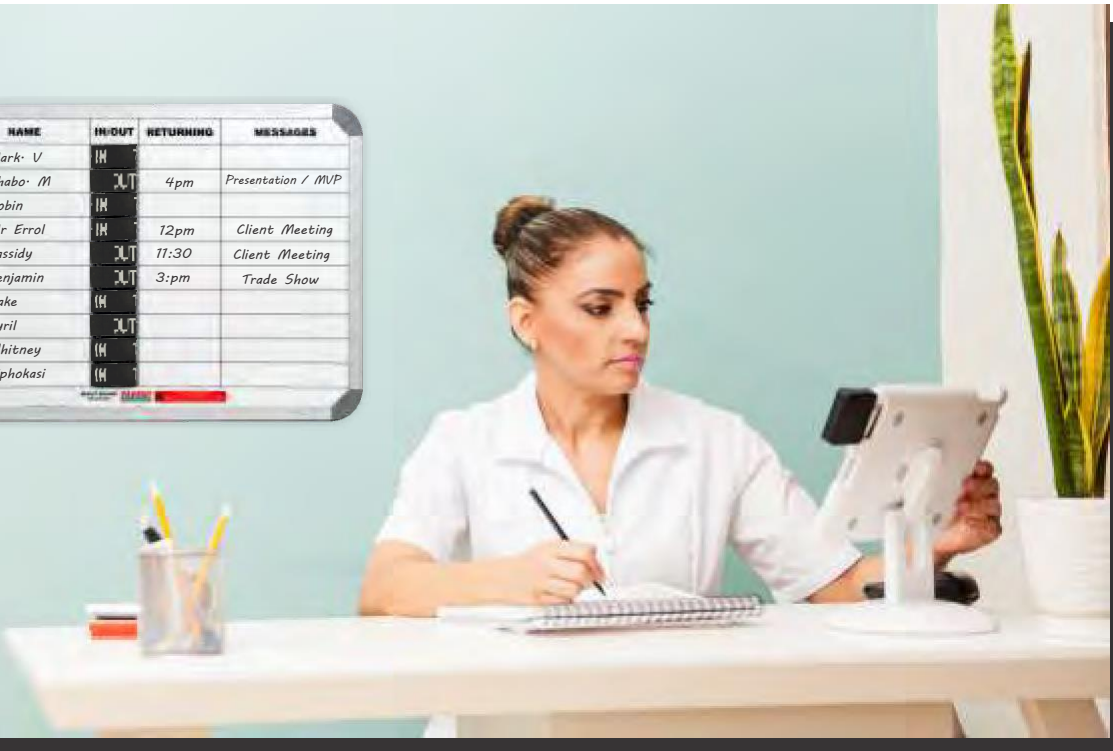

| Code | Description | Size |
|--------|---------------------------------|-------------|
| BD4010 | In / Out Board Magnetic 10 Name | 600 x 450mm |
| BD4020 | In / Out Board Magnetic 20 Name | 900 x 600mm |

- Concealed mounting (wall screws and masonry plugs supplied, 6mm).
- Slide-in aluminium pentray (450 x 35mm).
- Pentray packed in back of board to ensure no damages while being transported.
- Can be used with the Easy Rail System
- In / Out slides included.
- Names can be personalised to suit your requirements.
- Column sizes:
Name - 200 x 35mm.
In / Out - 68 x 35mm.
Returning - 112 x 35mm.
Messages - 190 x 35mm.



Concealed mounting

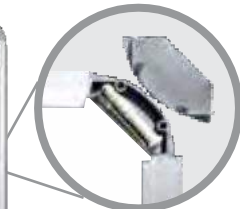

Standard Frame
20mm wide



Concealed mounting

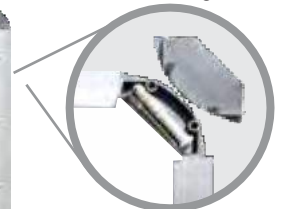

Standard Frame
20mm wide



For Personalised In/Out Boards contact our Call Centre

Synthetic Wooden Frames



Product Features

- Synthetic wood moulding. Can be used with most surfaces in our range.
- Frame 39mm wide.
- Frame depth 23mm.
- Up to 3000mm in length.
- Match accent colours of interior decor

Available in the following simulated wood finishes:



Frame
39mm wide

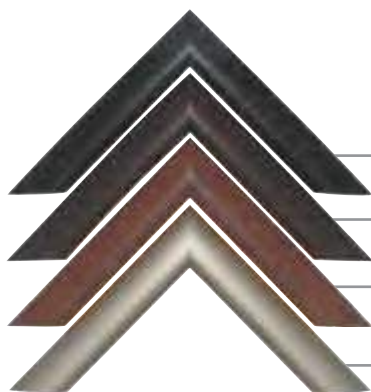

Black (WF001)

Imbuia (WF1002)

Cherry (WF1003)

Matte Silver (WF1005)



Abacus

| Code | Description | Size |
|----------|----------------------------|-------------|
| AB1010 | Abacus 100 Beads | 230 x 153mm |
| AB1010-Z | Abacus 100 Beads Box of 40 | |



- Calculation tool used to demonstrate maths concepts
- Abacus allows children to visually and tangibly move beads as they count, add, subtract, multiply, identify place value and more
- 10 rows
- **Colours:** blue, yellow, orange, green & red

Desktop Calculator

| Code | Description |
|--------|-----------------------------|
| AB0012 | Calculator Desktop 12 Digit |

Dual power supply
Solar and battery operated

- 12 Digits
- Auto/Manual power off
- Memory function
- Large LCD display
- Batteries not included (1 x AG10)

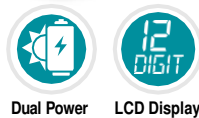

Flexible Ruler

| Code | Description |
|--------|---------------------|
| SA0030 | Flexible Ruler 30cm |

- 30cm shatterproof flexible ruler
- Measures in CM and MM



Include colour code when ordering
Available colours - ex stock:
Colour codes: Pink(P), Blue(D), Clear(T)



Scissors

| Code | Description |
|--------|----------------------|
| SA1014 | Scissors 14cm - Lime |
| SA1018 | Scissors 18cm - Grey |

- | | |
|--|--|
| <ul style="list-style-type: none"> • For school & home use • Blade length: 14cm • Blade thickness: 1.5mm • Rounded Safety tips • Comfort grip handles | <ul style="list-style-type: none"> • For office & home use • Blade length: 18cm • Blade thickness: 1.8mm • Rounded Safety tips • Comfort grip handles |
|--|--|



SA1014



SA1018

Arts & Crafts Glue

| Code | Description |
|--------|---------------------------|
| SA2250 | Arts And Craft Glue 250ml |
| SA2005 | Arts And Craft Glue - 5L |

- High quality adhesive
- Suitable for DIY, hobby, craft and school projects
- Fast drying
- Applications: Paper, cardboard, cork, most types of woods and wooden materials
- Characteristics:
 - Solvent-free
 - Suitable and safe for children
 - Can be applied to one surface only and joined immediately
 - VAE based adhesive



SA2250



SA2005

Board Accessories

Vinyl Lining Tape

| Code | Colour | Size |
|--------|--------|-----------|
| VT7003 | Black | 10m x 3mm |
| VT7004 | Red | 10m x 3mm |
| VT7005 | Blue | 10m x 3mm |
| VT7006 | Black | 10m x 6mm |
| VT7007 | Red | 10m x 6mm |
| VT7008 | Blue | 10m x 6mm |

- Recommended for advertising, vehicle and general signage.
- Ideal on Whiteboards.

Available colours:

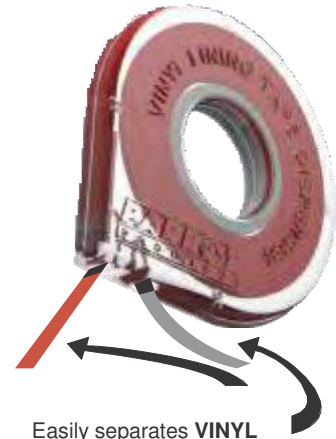

Easily separates VINYL from BACKING TAPE

Flexible Magnetic Sheeting

| Code | Size |
|--------|--------------------|
| BA1161 | 1000 x 610 x 0.8mm |

- Recommended for use on Magnetic Boards or any steel surface.
- Can be cut with scissors.
- No Write 'n Wipe ability.
- Magnetic Sheeting can have any digital print applied upon request.

Available colours:



*** While stocks last**

*Magnetic sheeting with no colour.



Magnetic Ruler ACP

Code **Size**

BA0211 1000mm

- 1000mm magnetic Ruler
- Aluminium handle
- Metric measurements
- Perfect for magnetic chalk boards and whiteboards



Flexible Magnetic Strips

Code **Size**

BA1110 1000mm(2 x 500mm) x 10mm x 0.8mm

BA1115 1000mm(2 x 500mm) x 15mm x 0.8mm

BA1120 1000mm(2 x 500mm) x 20mm x 0.8mm

- Recommended for use on Magnetic Boards or any steel surface.
- Writeable surface, ideal for labels or planning boards, can be cut with scissors.

Available colours:



Include colour code when ordering

Available colours - ex stock:

Colour codes: Yellow(Y), Blue(S), Red(R), Black(B), Orange(O), White(W), Green(G)

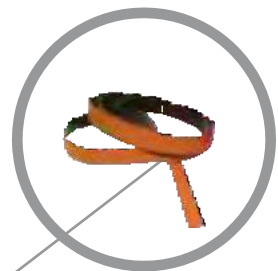

Flexible Magnetic Strips

*** Supplied in two strips of 500mm**

Flexible Magnetic Shapes

Code **Size**

BA1195 15mm

- Two of each shape in each colour: red, blue, orange, green & black.
- No Write 'n Wipe ability.
- **5 Shapes in each pack:** circles, squares, triangles, stars & arrows.
- **Bulk of single shapes or colours can be made to order (lead times apply).**

Available colours: (for bulk orders)

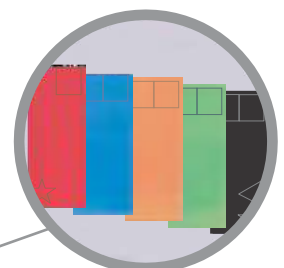

Flexible Magnetic Shapes

Board Accessories

Magnetic Photo Paper & Magnetic Tape

| Code | Description | Size |
|--------|--|-------------------|
| BA1196 | Magnetic Flexible Tape S/Adhesive | 3m x 19mm x 0.3mm |
| BA1197 | Magnetic Flexible Photo Paper A4 (3 sheets) | 210 x 297mm |

- **Magnetic Self-Adhesive Tape** - Use to mount menu's, to do lists, family notes, pictures & children's artwork. To use on magnetic-receptive surfaces.
- **Magnetic Photo Quality Paper** - Print photo's, educational aids, fridge magnets, gifts, souvenirs & business cards. Not weatherproof or bendable. Material - Semi - Anisotropic. 1.5mm thick. Magnetic strength 130 Gauss.



BA1197



BA1196

Moulded Magnets



Actual Size



Holds up to 8
A4 80gsm pages | Holds up to 4
A3 80gsm pages



Actual Size



Holds up to 6
A4 80gsm pages | Holds up to 3
A3 80gsm pages



Actual Size



Holds up to 4
A4 80gsm pages | Holds up to 2
A3 80gsm pages

| Code | Description | Size |
|--------|--|------|
| BA0605 | Magnets Circle (6 per card) | 20mm |
| BA0608 | Magnets Circle (5 per card - excludes white) | 30mm |
| BA0612 | Magnets Circle (4 per card - excludes white & black) | 40mm |

- Moulded plastic magnets. • Available in packs of assorted colours only.

* Not Suitable for use on magnetic glassboards

Available colours



Moulded Magnets - Extra Strength

| Code | Description | Size |
|--------|---|------|
| BA0609 | Magnetic Circle Extra-Strength (5 per card) | 30mm |

- Available in white only.
- Recommended for Glass/Whiteboards (See pages 6 - 10 for Glass Whiteboards)

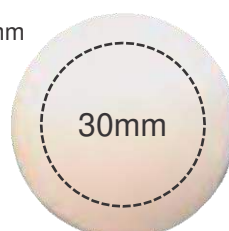

Holds up to 6
A4 80gsm pages

Holds up to 4
A3 80gsm pages

Holds 1 laminated
A4 80gsm pages

Cannot hold laminated
A3 80gsm pages

Magnetic Map Pins

| Code | Description | Size |
|---------|--|------|
| BA0915 | 6 per card - black, white, red, blue, green & yellow | 16mm |
| BA0915B | Box 25 - Black | 16mm |
| BA0915W | Box 25 - White | 16mm |
| BA0915Y | Box 25 - Yellow | 16mm |
| BA0915R | Box 25 - Red | 16mm |
| BA0915G | Box 25 - Green | 16mm |
| BA0914 | 4 per card - excl black & white* | 30mm |
| BA0922 | 2 per card - red & yellow only | 36mm |

- Carded packs available in assorted colours only.
- Magnetic Map Pins pictured actual size.



Available colours



Magnetic Label Carriers - Pack of 10

| Code | Size |
|--------|------------|
| BA1130 | 20 x 60mm |
| BA1131 | 20 x 80mm |
| BA1132 | 20 x 100mm |

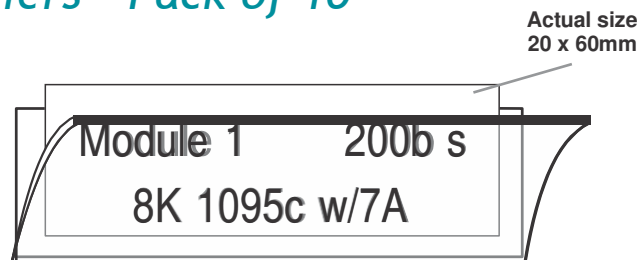

- Magnet-backed plastic holders for mounting of paper labels. • Paper labels not included.

Drawing Pins & Push Pins

| Code | Description |
|---------|-----------------------------|
| BA3001 | Push Pins Boxed 30 Assorted |
| BA3001B | Push Pins Boxed 30 Black |
| BA3001D | Push Pins Boxed 30 Blue |
| BA3001G | Push Pins Boxed 30 Green |
| BA3001R | Push Pins Boxed 30 Red |
| BA3001Y | Push Pins Boxed 30 Yellow |
| BA3002 | Drawing Pins Boxed 100 |
| BA3003 | Giant Push Pins Boxed 15 |
| BA3004 | Hexagonal Pins Boxed 30 |
| BA3005 | Map Pins Boxed 100 |
| BA3007 | Drawing Pins Brass Pack 100 |



- Map Pins - coloured heads for coding.
- All pins in assorted colours only, except BA3001 - Thumb Tacks Boxed 25.
- Push Pins - long heads, can be used as hooks.
- Drawing Pins - flat plastic heads.
- Giant Push Pins - easy grip.
- Hexagonal Pins - paper labels on heads for coding.



• All pins supplied in a storeable plastic box.

Board Accessories

Dusters - Wood Chalk Board

| Code | Description | Size |
|----------|---|------------|
| BA0115 | Duster - Carded Grey | 95 x 35mm |
| BA0115B* | Duster - Uncarded Grey (Pack of 10) | 95 x 35mm |
| BA0116A | Duster - Boxed 100 Green | 150 x 35mm |
| BA0116B | Duster - Uncarded Green(Pack of 10) | 150 x 35mm |
| BA0117A* | Duster - Boxed 100 Grey | 150 x 35mm |
| BA0118 | Mini Duster - Uncarded Green (Pack of 10) | 50 x 35mm |

- For use on Chalk Boards and Chalk Writing Slates.
- Chalk Dusters supplied with wooden handles.
- High-quality green or grey felt.



(New Mini Duster)

*** While stocks last**

Erasers & Aqua Wipes

| Code | Description | Size |
|--------|--|-------------|
| BA0101 | Eraser Whiteboard - 12 peel-off layers | 95 x 50mm |
| BA0102 | Eraser Whiteboard - 12 peel-off layers | 145 x 50mm |
| BA0105 | Eraser Magnetic Whiteboard | 145 x 55mm |
| BA0106 | Eraser Magnetic Refill (12 per pack) | 145 x 55mm |
| BA0110 | Eraser Aqua Wipe | 400 x 300mm |

- Non-Magnetic Erasers have 12 peel off layers.
- Magnetic Eraser refill pads are available.
- Aqua Wipe - highly absorbent, removes smudging, staining and ghosting on Whiteboard surfaces.



Aqua Wipe

Do Not Wash With Detergents

Pen and Eraser Holder Magnetic

| Code | Size |
|---------|-------------|
| BA0210* | 210 x 210mm |

- Holds up to 10 Whiteboard Markers and a Whiteboard Eraser.
- Perfect for office and home use.
- Efficiently stores and organizes accessories.
- Visibility of accessories for easy reach.

*** Accessories not included**

*** While stocks last**



Whiteboard Cleaning Fluid

Code Description

- BA0201 250ml Bottle Carded
- BA0201Z 250ml Box of 6 Uncarded



BA0201

BA0201Z

Office Equipment Cleaning Fluid

Code Description

- BA0203 Fluid 250ml Bottle Carded
- BA0203Z Fluid 250ml Box of 6 Uncarded

Aerosol Whiteboard Cleaner

Code Description

- BA0205 Cleaning Fluid Whiteboard Aerosol 400ml Single
- BA0205Z Cleaning Fluid Whiteboard Aerosol 400ml Box of 12

- Removes stains, marks & Permanent Marker ink from Whiteboard surfaces.
- Ideal as an office equipment cleaning solution.
- Ideal for all Whiteboard & Glassboard surfaces
- Antibacterial, Antiviral & Antifungal Sanitizing Solution



BA0205

While stocks last

Whiteboard Starter Pack

Code Description

- BA0200 Starter Pack Whiteboard

• Starter Pack contains:

- 2 Whiteboard Markers
- 1 Cloth
- 1 Eraser (95 x 55mm)
- 1 Cleaning Fluid (250ml)

Code Description

- BA0202 Starter Pack Whiteboard Magnetic

• Magnetic Starter Pack contains:

- 2 Whiteboard Markers
- 1 Cloth
- 1 Magnetic Eraser (145 x 55mm)
- 1 Cleaning Fluid (250ml)
- 4 Moulded Magnets (20mm)



BA0200



BA0202

Chalk & Chalk Holder

Code Description

- CH0012A* Chalk Dustless Box 12 Assorted Colours
- CH0012W* Chalk Dustless Box 12 White
- CH0001Y Chalk Holder Plastic Single



*** While stocks last**

Whiteboard Markers

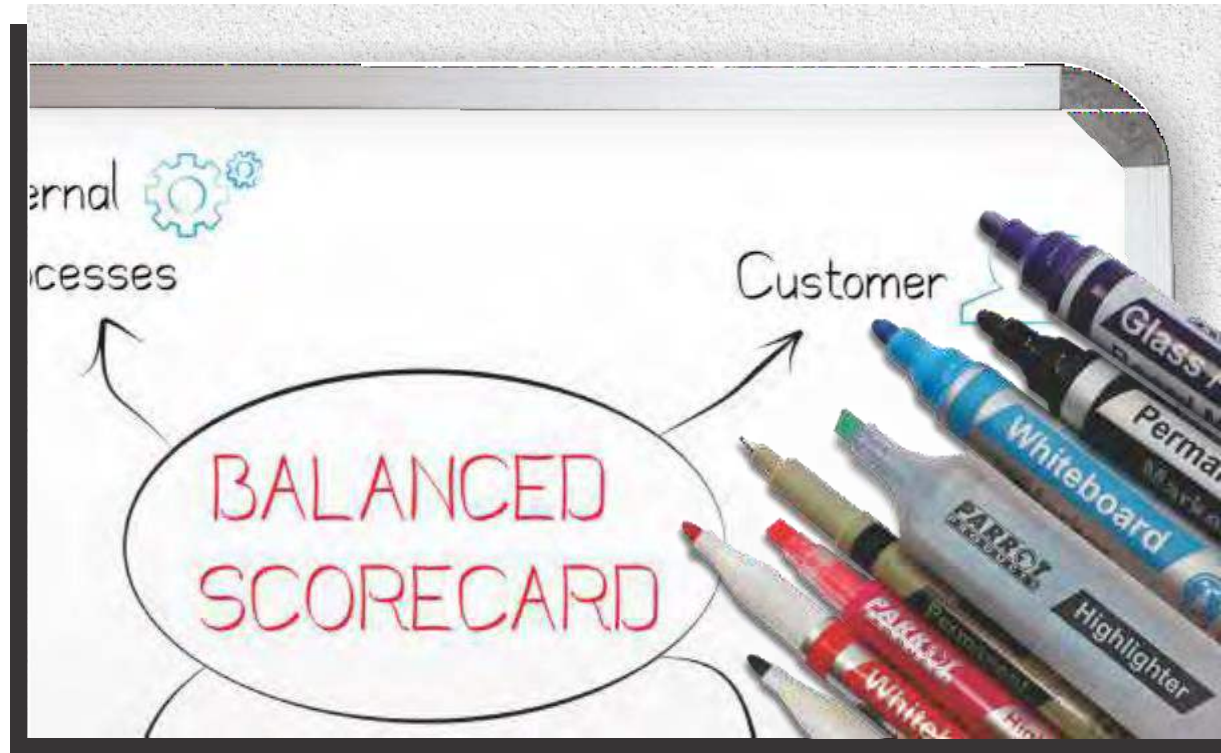

Single Carded Bullet Tip

Code Description

| | | |
|---------|--------------------------|--------------|
| PW0101B | Marker Whiteboard Bullet | Carded Black |
| PW0101D | Marker Whiteboard Bullet | Carded Blue |
| PW0101R | Marker Whiteboard Bullet | Carded Red |
| PW0101G | Marker Whiteboard Bullet | Carded Green |



PW0101

BULLET TIP
Nib Size: 3mm



Assorted 4, 6 & 10 Slimline & Bullet Tip

Code Description

| | | |
|----------|----------------------------|--------------|
| PW0401A* | Marker Whiteboard Bullet | Pouch 4 |
| PW0601A* | Marker Whiteboard Bullet | Pouch 6 |
| PW0401B* | Marker Whiteboard Slimline | Pouch 4 |
| PW0601B* | Marker Whiteboard Slimline | Pouch 6 |
| PW1001A* | Marker Whiteboard Bullet | Pouch 10 |
| PW1001B | Marker Whiteboard Bullet | Box 10 Black |
| PW1001D | Marker Whiteboard Bullet | Box 10 Blue |
| PW1001R | Marker Whiteboard Bullet | Box 10 Red |
| PW1001G | Marker Whiteboard Bullet | Box 10 Green |
| PW2001B | Marker Whiteboard Slimline | Box 10 Black |
| PW2001D | Marker Whiteboard Slimline | Box 10 Blue |
| PW2001R | Marker Whiteboard Slimline | Box 10 Red |
| PW2001G | Marker Whiteboard Slimline | Box 10 Green |

* Reusable pouch included



Available colours:



Slimline
Box of 10



Slimline
Pouch 4



Bullet
Pouch 6

SLIMLINE TIP
Nib Size: 2mm



BULLET TIP
Nib Size: 3mm





Bullet Tip

| Code | Description |
|---------|---------------------|
| PP0101B | Single Carded Black |
| PP1001B | Box 10 Black |

- Permanent Marker ink on Whiteboards can be removed with Whiteboard Cleaner.

* Available in black only

BULLET TIP
Nib Size: 3mm



Chisel Tip

| Code | Description |
|---------|---------------------|
| PP0301B | Single Carded Black |
| PP3001B | Box of 10 Black |

- Low odour
- Quick drying
- Fibre nib for smooth writing
- High intensity permanent ink

* Available in black only

CHISEL TIP
Nib Size: 5mm



Permanent Markers

Ultra Finesline

Code Description

| | | |
|---------|----------------------------------|---------------|
| PP0201B | Permanent Marker Ultra Finesline | Single Carded |
| PP2001B | Permanent Marker Ultra Finesline | Box of 12 |

- Low odour
- Quick drying
- Fibre nib for smooth writing
- High intensity permanent ink

* Available in black only

ULTRA FINELINE
Nib Size: 0.5mm



Box of 12



Single Carded

Marker Magnetic/Eraser

Code

PW0101M

- Ideal for refrigerator doors.
- Magnetic cap.
- Integrated eraser.
- Xylene and Toluene free.

BULLET TIP
Nib Size: 2mm



Magnetic Cap
with Eraser



Glass/Chalk Board Markers

To do this week:

- Take pet to vet
- Parent meeting 6:30pm tuesday
- Groceries friday



Code Description

| | | |
|----------|-----------------------------------|------------------|
| PC1001A | Marker Glass / Chalk Board White | Box of 10 |
| PC0602A* | Marker Glass / Chalk Board Bullet | Pouch 4 Assorted |
| PC0602B | Marker Glass / Chalk Board Bullet | Pouch 4 Assorted |

*** While stocks last**

- Low odour
- Pump action marker
- Fibre nib for smooth writing
- Writes on dark / light board surfaces
- Not for use on chalk board paint surfaces
- Suitable for Black Boards, Whiteboards, Chalk Boards and Glass Boards.
- Wet-Erase Marker, can be erased with a wet cloth.



PC0602A

*Available colours:



BULLET TIP
Nib Size: 4mm



PC1001A



PC0602B

Highlighters



Assorted Pouch 4, Box of 10 - Chisel Tip

Highlighter design / model may vary

Code Description

PH0401B Pouch 4 Assorted
PH1001 Box of 10

- Non-fading Highlighter.
- Copier, fax and scanner friendly.



Pouch 4 available colours:



Box of 10 available colours:



Include colour code when ordering

Available colours - ex stock:

Colour codes: Yellow(Y), Pink(P), Orange(O), Blue(S), Green(G), Violet(V)

Assorted Pouch 4, Box of 10 - Slimline

Code Description

PH2001P Marker Highlighter Slimline Box 12 Pink
PH2001S Marker Highlighter Slimline Box 12 Blue
PH2001O Marker Highlighter Slimline Box 12 Orange
PH2001Y Marker Highlighter Slimline Box 12 Yellow
PH0401C Marker Highlighter Slimline Pouch 4 Assorted

- Low odour
- Quick drying
- Fibre nib for smooth writing
- Fluorescent ink

*Available colours:





S100

| Code | Description | Size |
|------|--|---------------|
| S100 | Shredder Paper 5 sheets (strip cut 6.8mm) | 300*150*280mm |

- 2min continuous use (cool off period 45min)
- Overheat protection • Auto on / off
- Manual reverse • Staple friendly
- Extendable Arm: Extends 68mm to accommodate shredding over larger waste bins
- 10 Litre waste bin



* While stocks last



S1006S

| Code | Description | Size |
|--------|--|---------------|
| S1006S | Shredder Paper 6 sheets (strip cut 6mm) | 330*155*375mm |

- 2 min continuous use (cool off period 15min)
- Overheat protection • Manual reverse
- Staple friendly
- Extendable Arm: Extends to 68mm to accommodate shredding over larger waste bins
- 10 Litre waste bin

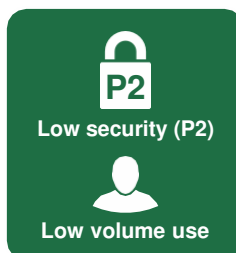
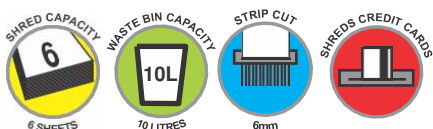

Shredders

S200

| Code | Description | Size |
|------|---|---------------|
| S200 | Shredder Paper 8 sheets (cross cut 5*38mm) | 320*190*366mm |

- 2min continuous use (cool off period 30min)
- Auto on / off • Auto reverse
- Staple friendly
- Shreds paper & credit cards
- Shred capacity: 8 sheets
- 16 Litre waste bin

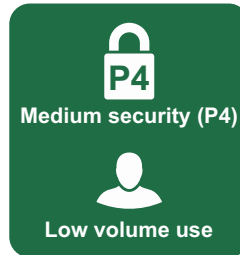
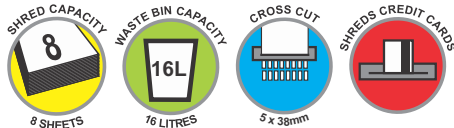

* While stocks last



S1008CC

| Code | Description | Size |
|---------|---|---------------|
| S1008CC | Shredder Paper 8 sheets (cross cut 5*47mm) | 306*170*425mm |

- 2-3min continuous use (cool off period 30min)
- Overheat protection
- Auto on / off • Auto reverse
- Staple friendly
- Shreds paper & credit cards
- 13 Litre waste bin

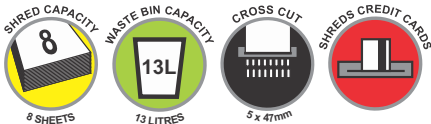

S1012CC

| Code | Description | Size |
|---------|--|---------------|
| S1012CC | Shredder Paper 12 sheets (cross cut 5*40mm) | 329*226*495mm |

- 7min continuous use (cool off period 45min)
- Overheat protection
- Auto on / off
- Auto & Manual forward / reverse
- 15 Litre waste bin

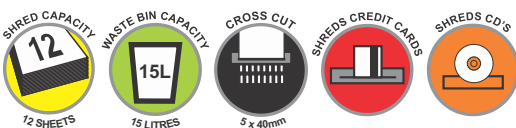

S516

| Code | Description | Size |
|------|--|---------------|
| S516 | Shredder Paper 16 sheets (cross cut 3.9*44mm) | 373*277*645mm |

- 7min continuous use (cool off period 45min)
- Overheat protection
- Auto on / off
- Manual forward / reverse
- Auto stop when waste bin is full
- 28 Litre waste bin

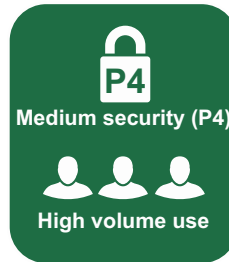
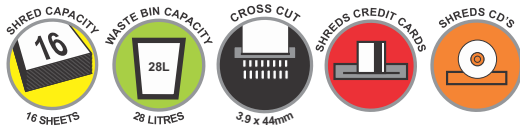

* While stocks last



S1024CC

| Code | Description | Size |
|---------|--|---------------|
| S1024CC | Shredder Paper 24 sheets (cross cut 4*38mm) | 385*280*669mm |

- 40min continuous use (cool off period 45min)
- Overheat protection
- Auto on / off
- Auto & Manual forward / reverse
- 26.5 Litre waste bin

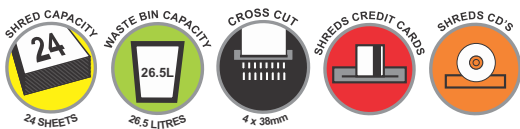

S1008MC

| Code | Description | Size |
|---------|--|---------------|
| S1008MC | Shredder Paper 8 sheets (Mini cross cut 4*12mm) | 329*226*495mm |

- 5min continuous use (cool off period 30min)
- Overheat protection
- Auto on / off
- Auto forward / reverse
- 15 Litre waste bin

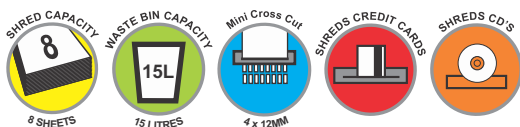

Shredders

S605

| Code | Description | Size |
|------|---|---------------|
| S605 | Shredder Paper 75 sheets Auto Feed (Micro cut 3*9mm) | 370*265*492mm |

- 15min continuous use (cool off period 30min)
- Auto shred 75 sheets
- Shred capacity: 6 sheets
- Auto on / off / reverse • Manual forward / reverse.
- Overload protection
- Staple friendly
- 23 Litre waste bin

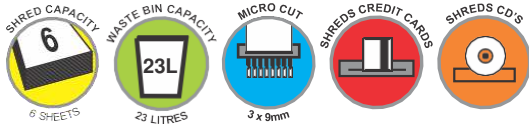

S801

| Code | Description | Size |
|------|--|---------------|
| S801 | Shredder Paper 60 sheets Auto Feed (cross cut 4*30mm) | 345*269*555mm |

- 5min continuous use (cool off period 40min)
- Auto Feed function 60 sheets.
- Auto on / off • Manual forward / reverse
- Shred capacity: 8 sheets
- Auto stop when waste bin is full
- 22 Litre waste bin.

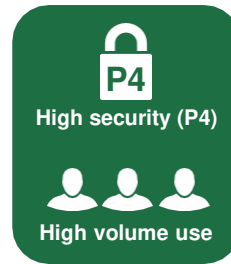
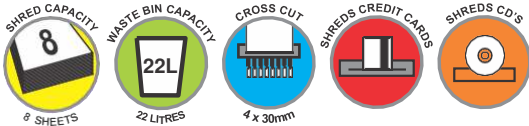

BA0252

| Code | Description |
|--------|--------------------|
| BA0252 | Shredder Oil 250ml |

- Eliminates build-up of paper dust • Prevents jamming
- Conditions blades to extend shredder lifespan

Why oil your shredder?











- It is very important to keep oiling the cutting cylinders on your shredder
- It will prolong the life of your shredder and will prevent annoying squeaks that may occur

Shredding machines that are not oiled will:

- Take longer to shred
- Be more prone to jamming
- Start to shred fewer sheets of paper per pass per minute



Shredders Comparison

| | S100 | S1006S | S200 | S1008CC | S1012CC | S516 | S1024CC | S1008MC | S605 | S801 |
|---------------------------------|---|---|---|---|---|--|---|---|---|---|
| Noise level | 72Db | 70Db | 72Db | 70Db | 65Db | 60Db | 65Db | 65Db | 60Db | 55Db |
| Security level | P2 | P2 | P4 | P3 | P3 | P4 | P4 | P4 | P4 | P4 |
| Cut Size | 6.8mm | 6mm | 5x38mm | 5x47mm | 5x40mm | 3.9x44mm | 4x38mm | 4x12mm | 3x9mm | 4x30mm |
| Strip Cut | ✓ | ✓ | | | | | | | | |
| Cross Cut | | | ✓ | ✓ | ✓ | ✓ | ✓ | ✓ | | ✓ |
| Micro Cut | | | | | | | | | ✓ | |
| Entry Width | 220mm | 220mm | 223mm | 220mm | 220mm | 225mm | 220mm | 220mm | 220mm | 225mm |
| Shred Capacity (80g A4) | 5pg | 6pg | 8pg | 8pg | 12pg | 16pg | 24pg | 8pg | 6pg | 8pg |
| Waste Basket Capacity Litres | 10Ltr | 10Ltr | 16Ltr | 13Ltr | 15Ltr | 28Ltr | 26.5Ltr | 15Ltr | 23Ltr | 22Ltr |
| Speed (Meters per min) | 3m/min | 2.9m/min | 2m/min | 2.5m/min | 2m/min | 2m/min | 1.8m/min | 2m/min | 2m/min | 2.4m/min |
| Motor | 100w | 220V | 220w | 220V | 220V | 270w | 220V | 220V | 210w | 145w |
| Dimensions | 300x150x280mm | 330x155x375mm | 320x190x366mm | 306x170x420mm | 329x226x495mm | 645x373x277mm | 385x280x669mm | 329x226x495mm | 492x265x370mm | 555x269x345mm |
| Carton Dimensions | 282x152x268mm | 372x331x306mm | 376x330x205mm | 380x340x400mm | 543x383x472mm | 688x418x308mm | 477x375x687mm | 543x383x472mm | 552x315x420mm | 648x345x425mm |
| Nett Weight | 1.1kg | 2.05kg | 3.5kg | 3.79kg | 7.7kg | 9.6kg | 14.3kg | 7.8kg | 9.5kg | 10kg |
| Auto On / Off | ✓ | ✓ | ✓ | ✓ | ✓ | ✓ | ✓ | ✓ | ✓ | ✓ |
| Forward / Reverse | Manual | Manual | Auto Reverse | Auto | Auto / Manual | Manual | Auto / Manual | Auto | Manual | Manual |
| Auto Reverse Overload Function | | ✓ | | ✓ | ✓ | ✓ | ✓ | ✓ | ✓ | |
| Shred CD's and Credit Cards | | Credit Card | ✓ | Credit Card | ✓ | ✓ | ✓ | ✓ | ✓ | ✓ |
| Staple Friendly | ✓ | ✓ | ✓ | ✓ | ✓ | ✓ | ✓ | ✓ | ✓ | ✓ |
| Castors | No | No | No | No | Yes | Plastic | Yes | Yes | Yes | Plastic |
| Retail Packaging | Yes | Yes | Yes | Yes | Yes | Yes | Yes | Yes | Yes | Yes |
| Use | Home/Office | Home/Office | Home/Office | Home/Office | Home/Office | Small Office | Home/Office | Small Office | Home/Office | Home/Office |
| | Low Use Low Jam Risk | Low Use Low Jam Risk | Low Use Low Jam Risk | Medium Use Low Jam Risk | Medium Use Low Jam Risk | Medium Use Low Jam Risk | High Use Low Jam Risk | High Use Low Jam Risk | High Use Low Jam Risk | High Use Low Jam Risk |
| Duty Cycle | 2 Minutes On | 2-3 Minutes On | 2 Minutes On | 2 Minutes On | 7 Minutes On | 7 Minutes On | 40 Minutes On | 5 Minutes On | 24hrs a day Integrated Cooling System Inside Machine | 5 Minutes On |
| Cool Off Period | 45 Minutes Off | 15 Minutes Off | 30 Minutes Off | 30 Minutes Off | 45 Minutes Off | 45 Minutes Off | 45 Minutes Off | 30 Minutes Off | | 40 Minutes Off |
| Shred Paper Size Actual Size |  |  |  |  |  |  |  |  |  |  |
| | 6.8mm | 6mm | 5x38mm | 5x47mm | 5x40mm | 3.9x44mm | 4x38mm | 4x12mm | 3x9mm | 4x30mm |

Specifications may change due to product improvements

Comb Binding Machines



B2988-4

| Code | Description | Size |
|---------|----------------------|-------------------|
| B2988-4 | Comb Binding Machine | 388 x 260 x 160mm |

- For office and home use.
- Punch up to 12 sheets of paper.
- Bind up to 450 sheets of paper.
- Punch 21 holes for comb binding.
- Punch 4 holes for ring binding.
- Bind with combs 6 to 51mm.

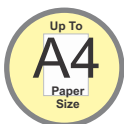

Comb Binding Machine

B2950

| Code | Description | Size |
|-------|----------------------|-------------------|
| B2950 | Comb Binding Machine | 390 x 231 x 100mm |

- For office and home use.
- Punch up to 8 sheets of paper.
- Bind up to 150 sheets of paper.
- Punch 21 holes for comb binding.
- Bind with combs 6 to 20mm.

*** While stocks last**

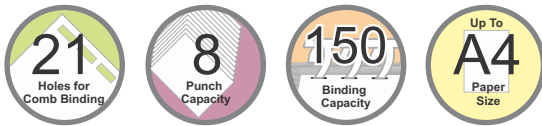

B2937 Heavy Duty

| Code | Description | Size |
|-------|----------------------|-------------------|
| B2937 | Comb Binding Machine | 388 x 260 x 160mm |

- For office and home use.
- Punch up to 15 sheets of paper.
- Bind up to 450 sheets of paper.
- 7 Pin adjuster for punching selection.
- Punch 21 holes for comb binding.
- Bind with combs 6 to 51mm.

*** While stocks last**

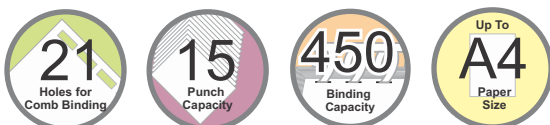

Blades

Craft Knife

| Code | Description |
|---------|--------------------------------|
| CK1010R | Craft Knife Metal Red |
| CK1011 | Craft Knife Blades Refill Pack |

- Strong steel casing.
- 8 snap-off 9mm 30° blades.
- Refill pack contains 10 blades.
- Useful tool for safely snapping off blades included on end of knife.

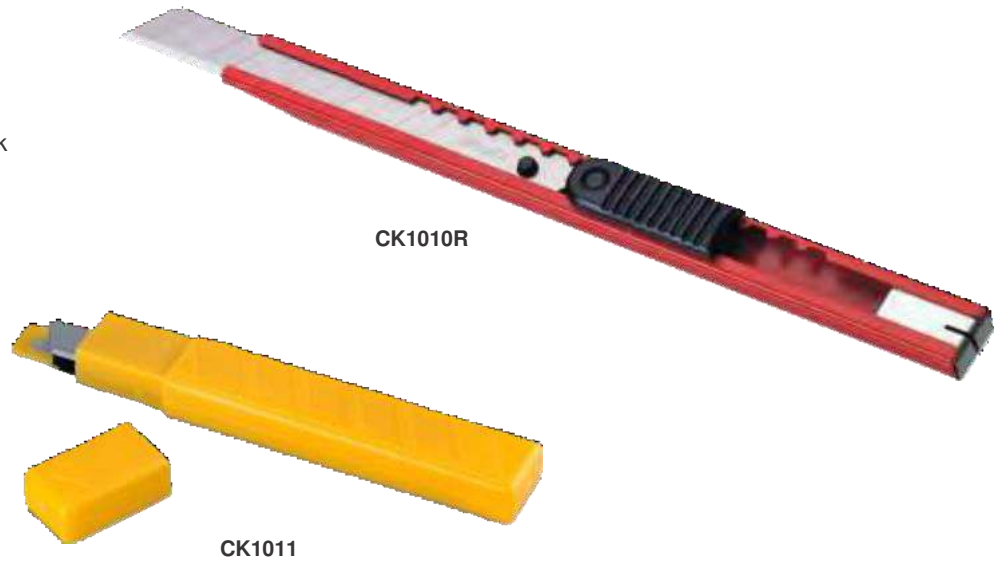

Craft Knife - Rotary Blade

| Code | Description | Size |
|---------|---|------|
| CK1110R | Craft Knife Rotary Plastic Red | |
| CK1111 | Craft Knife Rotary Straight Blades Refill Pack | 28mm |
| CK1112 | Craft Knife Rotary Perforating Blades Refill Pack | 28mm |
| Ck1113 | Craft Knife Rotary Pinking Blades Refill Pack | 28mm |

- Safety blade retraction system for when not in use.
- 28mm interchangeable blades.
- Refill pack contains 3 blades.



Pinking Blade



Perforating Blade

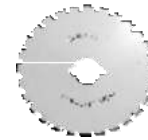

Straight Blade



Guillotines

Guillotines - Plastic Base



| Code | Description | Size |
|---------|---------------------------|-------------|
| GU2010 | Guillotine A4 - 10 Sheets | 437 x 337mm |
| GU2020* | Guillotine A4 - 20 Sheets | 437 x 337mm |

- Durable sharp blade capable of making over 1000 cuts.
- Page guide for straight cuts.
- Blade safety lock to ensure safety when the guillotine is not being used.
- Press clamp to hold pages to be cut in place.
- ABS safety shield.
- Max Cutting Length: 343.0mm.
- Cuts A6 - A4 Pages.

*** While stocks last**



GU2010



GU2020



Guillotines

Guillotines - Steel Base

| Code | Description | Size | Cutting Capacity (80gsm) |
|--------|------------------------|-------------|--------------------------|
| GU4010 | Guillotine Steel Base | 350 x 255mm | A4 - 20 Sheets |
| GU4020 | Guillotine Steel Base | 480 x 331mm | A3 - 20 Sheets |
| GU5010 | Guillotine Medium Duty | 445 x 226mm | A4 - 40 Sheets |

GU4010



- Integrated paper clamp system
- Page guide for straight cuts
- Blade safety lock to ensure safety when the guillotine is not being used
- Press clamp to hold pages to be cut in place
- ABS safety shield

GU5010



- High Carbon Steel Blade
(GU5010 Spare Blade Re-Order Code: AL3084)
(GU5010 Blade Sharpening Re-Order Code: AL3089)

GU4020



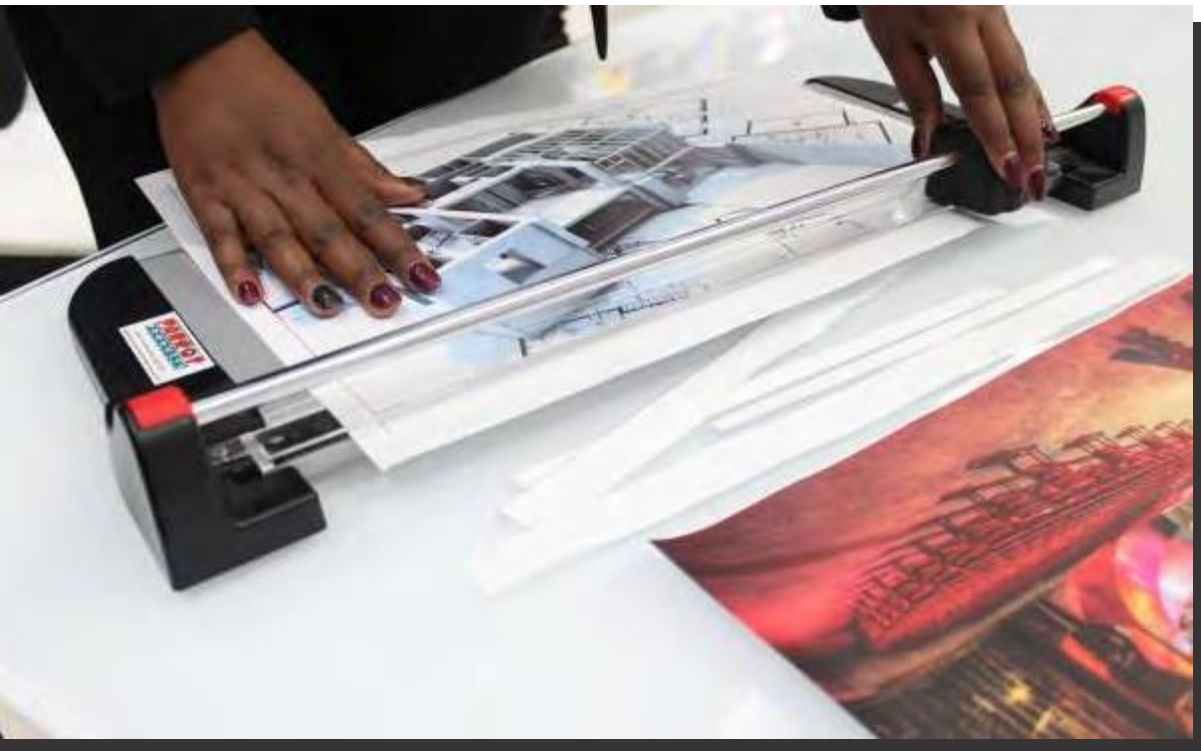

| Code | Description | Size |
|--------|-----------------------|------|
| RT4020 | 7 Sheets - Steel Base | A0 |

- Integrated clamp system.
- Measuring scale in Millimetres and Inches.
- Perfect for Home and Office use.
- Includes stand.
- Paper waste catchment tray, conveniently collects paper waste underneath the working table

- **Replacement Blades**
- Re-Order Code: AL3075

*** While stocks last**



Rotary Trimmers

Plastic & Steel Base

| Code | Description | Size |
|---------|--------------------------|------|
| RT1010 | 10 Sheets - Plastic Base | A4 |
| RT2020 | 7 Sheets - Steel Base | A3 |
| RT3010* | 15 Sheets - Steel Base | A4 |
| RT3020 | 15 Sheets - Steel Base | A3 |
| RT3030 | 12 Sheets - Steel Base | A2 |

- Automatic clamp system.
- Measuring scale in Millimetres and Inches.
- Perfect for Home and Office use.

• Replacement Blades

- RT1010 (Re-Order Code: AI3074)
- RT2020 (Re-Order Code: AL3076)
- RT3010, RT3020 & RT3030 (Re-Order Code: AL3075)

*** While stocks last**

10 Sheets - Plastic Base A4



RT1010

7 Sheets - Steel Base A3



RT2020

15 Sheets - Steel Base A4



RT3010

15 Sheets - Steel Base A3



RT3020

12 Sheets - Steel Base A2



RT3030



| Code | Description | Size | Speed |
|---------|---------------|------------------|-----------|
| LF9040R | A4 - 2 Roller | 346 x 150 x 85mm | 400mm/min |

LF9040R Retail Pack:

- For office and home use
- Ultra slim design
- Hot lamination
- Laminate up to 250 mic pouch
- 90 second warm up time
- High Speed: 400mm/min
- Overheating protection (power off)
- Auto power off 30min
- 10 X Free A4 Pouches



Laminators

| Code | Description | Size | Speed |
|--------|---------------|-----------------|-----------|
| LF9040 | A4 - 2 Roller | 370 x 80 x 45mm | 400mm/min |
| LF9041 | A3 - 2 Roller | 470 x 95 x 60mm | 400mm/min |

- For office and home use
- Ultra slim design
- Hot lamination (A4)
- Hot and cold lamination (A3)
- Jam release function (A3)
- Laminate up to 250 mic pouch
- 90 second warm up time
- High Speed: 400mm/min
- Overheating protection (power off)
- Auto power off 30min



• Ultra Slim Laminator - up to A4



LF9040

• Ultra Slim Laminator - up to A3



LF9041



Laminator Consumables

Laminating Pouches

| Code | Description | Size | Micron | |
|-----------|--|-------------|----------------|------------|
| LFA480 | Laminating Pouch A4 | 220 x 310mm | 160** (80+80)* | Box of 100 |
| LFA380 | Laminating Pouch A3 | 320 x 426mm | 160** (80+80)* | Box of 100 |
| LFA480/10 | Laminating Pouch A4 | 220 x 310mm | 160** (80+80)* | Pack 10 |
| LFA480/25 | Laminating Pouch A4 | 220 x 310mm | 160** (80+80)* | Pack 25 |
| LA1050 | Laminating Self Adhesive ID Tags & clips | 74 x 104mm | | Pack 6 |

* Thickness per side of pouch

** Total thickness both sides

| | Size | Usage |
|----|--|--|
| A3 |  305 x 426mm | To fit 297 x 420mm (11.69" x 16.53") A3 size paper |
| A4 |  220 x 310mm | To fit 210 x 297mm (8.26" x 11.69") A4 size paper |

LA1050



Heavy Duty Stapler 200 pages

| Code | Description | Size |
|---------|------------------------------|------------------|
| ST2076B | Heavy Duty Stapler 200 pages | 343 x 87 x 182mm |

- Loads 100 standard staple (Half strip)
- Staples 30-200 pages

| Staple Order Chart | | | |
|--------------------|-------|------------|--------|
| Order Code | Pages | Leg Length | Staple |
| SS023/8 | 50 | 8mm | 23/8 |
| SS023/10 | 50 | 23mm | 23/10 |
| SS023/13 | 100 | 13mm | 23/13 |
| SS023/23 | 200 | 23mm | 23/23 |



Available colours:



Heavy Duty Stapler 100 pages

| Code | Description | Size |
|---------|------------------------------|------------------|
| ST2066B | Heavy Duty Stapler 100 pages | 282 x 68 x 136mm |

- Loads 100 standard staple (Half Strip)
- Staples 30-200 pages

| Staple Order Chart | | | |
|--------------------|-------|------------|--------|
| Order Code | Pages | Leg Length | Staple |
| SS023/8 | 50 | 8mm | 23/8 |
| SS023/10 | 50 | 23mm | 23/10 |
| SS023/13 | 100 | 13mm | 23/13 |



Available colours:



Staplers

Long-Reach Stapler 20 pages

Code **Description** **Size**
 ST2055B Long-Reach Stapler 20 pages 405 x 52 x 55mm

- Loads 210 Standard staples. (Full Strip)
- Staples 20 pages.



| Staple Order Chart | | | |
|--------------------|-------|------------|--------|
| Order Code | Pages | Leg Length | Staple |
| SS024/6 | 20 | 6mm | 24/6 |
| SS026/6 | 30 | 6mm | 26/6 |

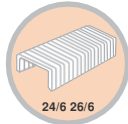

Available colours: ●

Plier Stapler Metallic 50 pages

Code **Description** **Size**
 ST2079M Plier Stapler Metallic 50 pages 195 x 27 x 64mm

- Loads 105 standard staples. (Half Strip)
- Staples 50 pages.



| Staple Order Chart | | | |
|--------------------|-------|------------|--------|
| Order Code | Pages | Leg Length | Staple |
| SS024/6 | 20 | 6mm | 24/6 |
| SS026/6 | 30 | 6mm | 26/6 |
| SS023/8 | 50 | 8mm | 23/8 |

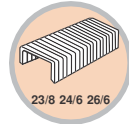

Available colours: ●

Plier Stapler 20 pages

Code **Description** **Size**
 ST2078B Plier Stapler 20 pages 172 x 30 x 63mm

- Loads 105 standard staples. (Half Strip)
- Staples 20 pages.
- Can also be used for tacking.



Available colours: ●

| Staple Order Chart | | | |
|--------------------|-------|------------|--------|
| Order Code | Pages | Leg Length | Staple |
| SS024/6 | 15 | 6mm | 24/6 |
| SS026/6 | 20 | 6mm | 26/6 |

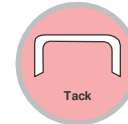
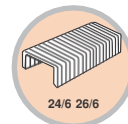

Plier Stapler 20 pages

Code Description

ST2080M Plier Stapler 20 pages 174 x 90 x 25

- Loads up 210 staples (Full Strip).
- Extra long throat design for easy stapling.
- Staple from any angle.
- Contoured grip to reduce hand fatigue.

| Staple Order Chart | | | |
|--------------------|-------|------------|--------|
| Order Code | Pages | Leg Length | Staple |
| SS024/6 | 20 | 6mm | 24/6 |

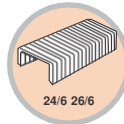

Available colours: ●

Front-Load Stapler 50 pages

Code Description

Size

ST3032B Front-Load Stapler 50 pages 182 x 49 x 74mm

- Loads 100 standard staple strip.
- Staples 50 pages.
- Can also be used for tacking.

| Staple Order Chart | | | |
|--------------------|-------|------------|--------|
| Order Code | Pages | Leg Length | Staple |
| SS024/6 | 20 | 6mm | 24/6 |
| SS026/6 | 30 | 6mm | 26/6 |
| SS023/8 | 50 | 8mm | 23/8 |

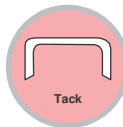
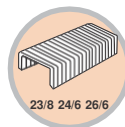

Available colours: ●

Desktop Stapler Steel Large 20 pages

Code Description

Size

ST2035M Large Metallic 20 pages 170 x 36 x 50mm
 ST2035B Large Black 20 pages 170 x 36 x 50mm

- Loads 210 standard staple (Full strip)
- Staples 20 pages.
- Can also be used for tacking.

| Staple Order Chart | | | |
|--------------------|-------|------------|--------|
| Order Code | Pages | Leg Length | Staple |
| SS024/6 | 20 | 6mm | 24/6 |
| SS026/6 | 30 | 6mm | 26/6 |

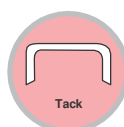
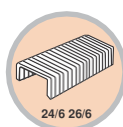

Available colours: ● ●

Staplers

Desktop Stapler Steel Medium 20 pages

Code **Description** **Size**
 ST2023M Medium Metallic 20 pages 137 x 37 x 55mm

- Loads 105 standard staples. (Half Strip)
- Staples 20 pages.

| Staple Order Chart | | | |
|--------------------|-------|------------|--------|
| Order Code | Pages | Leg Length | Staple |
| SS024/6 | 20 | 6mm | 24/6 |
| SS026/6 | 30 | 6mm | 26/6 |



Available colours: ●

Desktop Stapler Vertical 20 pages

Code **Description** **Size**
 ST2045L Desktop Stapler Vertical 20 pages 128 x 35 x 57mm

- Loads 105 standard staples. (Half Strip)
- Staples 20 pages.

| Staple Order Chart | | | |
|--------------------|-------|------------|--------|
| Order Code | Pages | Leg Length | Staple |
| SS024/6 | 20 | 6mm | 24/6 |
| SS026/6 | 30 | 6mm | 26/6 |

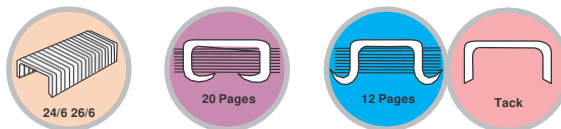

Stands vertically or horizontally



Available colours: ●

Desktop Stapler Large 20 pages

Code **Description** **Size**
 ST3048B Desktop Stapler Large 20 pages 163 x 37 x 60mm

- Loads 210 standard staples. (Full Strip)
- Staples 20 pages.

| Staple Order Chart | | | |
|--------------------|-------|------------|--------|
| Order Code | Pages | Leg Length | Staple |
| SS024/6 | 20 | 6mm | 24/6 |
| SS026/6 | 20 | 6mm | 26/6 |



Available colours: ●

Desktop Stapler Medium 20 pages

| Code | Description | Size |
|--------|------------------------------------|-----------------|
| ST3047 | Desktop Stapler Medium 20 pages | 134 x 35 x 54mm |

- Loads 105 standard staples. (Half Strip)
- Staples 20 pages.



| Staple Order Chart | | | |
|--------------------|-------|------------|--------|
| Order Code | Pages | Leg Length | Staple |
| SS024/6 | 20 | 6mm | 24/6 |
| SS026/6 | 30 | 6mm | 26/6 |



Available colours:

Stapler Light-Touch

| Code | Description | Size |
|---------|-----------------------------|-----------------|
| ST3060B | Light-Touch Stapler Plastic | 135 x 65 x 45mm |

- Loads 50 standard staple strips
- Staples 20 pages



| Staple Order Chart | | | |
|--------------------|-------|------------|--------|
| Order Code | Pages | Leg Length | Staple |
| SS024/6 | 20 | 6mm | 24/6 |
| SS026/6 | 30 | 6mm | 26/6 |

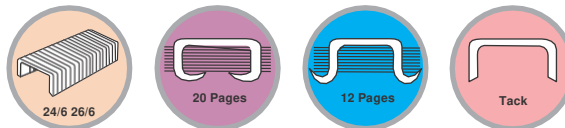

Available colours:

Stapler Mini 20 pages

| Code | Description |
|---------|-------------------------------------|
| ST3050 | Stapler Mini 20 pages + Staples |
| ST3051A | Stapler Mini 20 pages - 40 Assorted |
| ST3051 | Stapler Mini 20 pages - Single |

- Loads 50 standard staples.
- Staples 20 pages.
- For office and home use
- Durable and high quality
- Built-in staple remover
- Single units available to replenish stock



Supplied with 1000 Staples 26/6 (No.56)
Re-Order Code: SS026/6-1
ST3050

Include colour code when ordering
Available felt colours - ex stock:
Colour codes: Black(B), Blue(D), Green(G), Pink(P)



Built-in staple remover



Singles

ST3051

Include colour code when ordering
Available felt colours - ex stock:
Colour codes: Black(B), Blue(D), Green(G), Pink(P)



Staple Remover

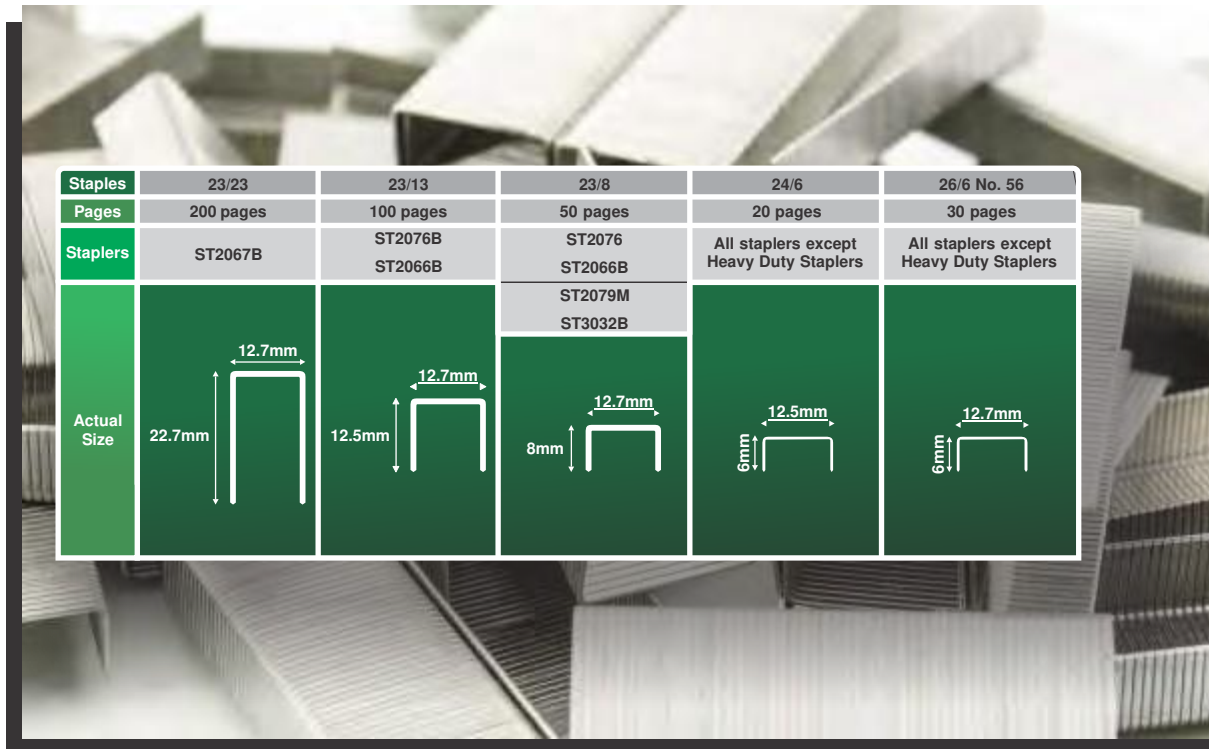

Code **Description** **Size**
 SR2018B Staple Remover 54 x 35 x 42mm

- For office and home use.
- Locks closed.
- Durable and high quality.



Available colours: ●

Staples

| Code | Description | Units |
|-----------|-----------------|------------|
| SS026/6-1 | Staples (No.56) | 26/6 1000 |
| SS026/6-5 | Staples (No.56) | 26/6 5000 |
| SS024/6 | Staples | 24/6 1000 |
| SS023/8 | Staples | 23/8 1000 |
| SS023/10 | Staples | 23/10 1000 |
| SS023/13 | Staples | 23/13 1000 |
| SS023/23 | Staples | 23/23 1000 |



See page 68 - 72 for Staplers

Punches

40 & 65 Sheet Punch



| Code | Description | Size |
|---------|----------------|-------------------|
| PU3084B | 40 Sheet Punch | 147 x 119 x 60mm |
| PU4065B | 65 Sheet Punch | 216 x 104 x 230mm |

- For office and home use.
- Punch up to 40/65 sheets.
- Centering arm adjustable to A4.
- Durable and high quality.



Available colours: ●



PU4065B



PU3084B

Punches

30 Sheet Punch

Code Description Size

PU3083 30 Sheet Punch 133 x 114 x 93mm

- For office and home use.
- Punch up to 30 sheets.



Available colours: ● ●

20 Sheet Punch

Code Description Size

PU2082 20 Sheet Punch 105 x 80 x 40mm

- For office and home use.
- Punch up to 20 sheets.

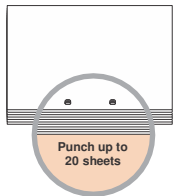

Available colours: ● ● ● ●

10 Sheet Punch

Code Description Size

PU2065 10 Sheet Punch 107 x 67 x 39mm

- For office and home use.
- Punch up to 10 sheets.



Available colours: ● ●

Carpet & Tile Protectors

Non Slip Tapered & Non-Slip Rectangle Shape



| Code | Description | Size |
|---------|--|--------------------|
| CP1042 | Carpet Protector Non-slip Grey Tapered | 1200 x 900 x 2.7mm |
| CP1043 | Carpet Protector Non-slip Silver Tapered | 1200 x 900 x 2.7mm |
| CP1044C | Floor Protector Ribbed Non-slip - Denim | 1200 x 850 x 5.5mm |
| CP1044Q | Floor Protector Ribbed Non-slip - Spice | 1200 x 850 x 5.5mm |
| CP1044T | Floor Protector Ribbed Non-slip - Tropical | 1200 x 850 x 5.5mm |
| CP1044X | Floor Protector Ribbed Non-slip - Laurel | 1200 x 850 x 5.5mm |
| CP1044Z | Floor Protector Ribbed Non-slip - Palm | 1200 x 850 x 5.5mm |

Carpet Protector

- Protects either carpet, wood or tiled surface
- Polycarbonate material
- Not impacted by use of heels on protected surface
- Easy to clean

Floor Protector

- Protects either carpet, wood or tiled surface
- Slip resistant rubberized backing
- Non-static

Available colours:

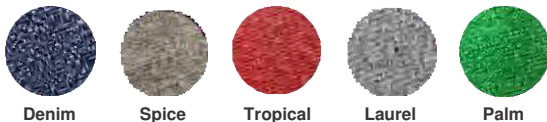

Denim

Spice

Tropical

Laurel

Palm



Floor Protector



Megaphone 25 Watt



Code Description

IS1001 Megaphone 25 Watt

- Long range - 700m
- Compact & powerful
- Clear sound
- ABS Body
- Dry Cell operation
- Built-in Siren & Microphone
- Operates with C batteries (not included with product)

How to operate:

- Open the back cover by pressing the latch.
- Insert 8 x C batteries.
- To activate the megaphone, switch the button to TALK, and press the button on the handle.
- Adjust the volume control to the desired volume whilst avoiding feedback.
- Switch the button to SIREN to activate the emergency siren.

* Enquire for availability



Volume Control



Built-in Microphone



Built-in Siren

Interactive Touch LED Panels



| Code | Description | Size |
|-------------|-----------------------------|------|
| TWB - 6519A | Interactive Touch LED Panel | 65" |
| TWB - 7519A | Interactive Touch LED Panel | 75" |
| TWB - 8619A | Interactive Touch LED Panel | 86" |

- Resolution: 1920 x 1080P / 3840 x 2160P
- Display Colours: 10bit
- Aspect Ratio: 16:9
- Outputs: AV x1/ Speaker x1/ SPDIF x1/ VGA x1
- Output: HDMI/VGA/USB
- Anti-Reflection Glass
- Touch Sensor: IR
- 6-Point Writing / 10-Point Touch
- Scan Speed: 8ms / 12ms.

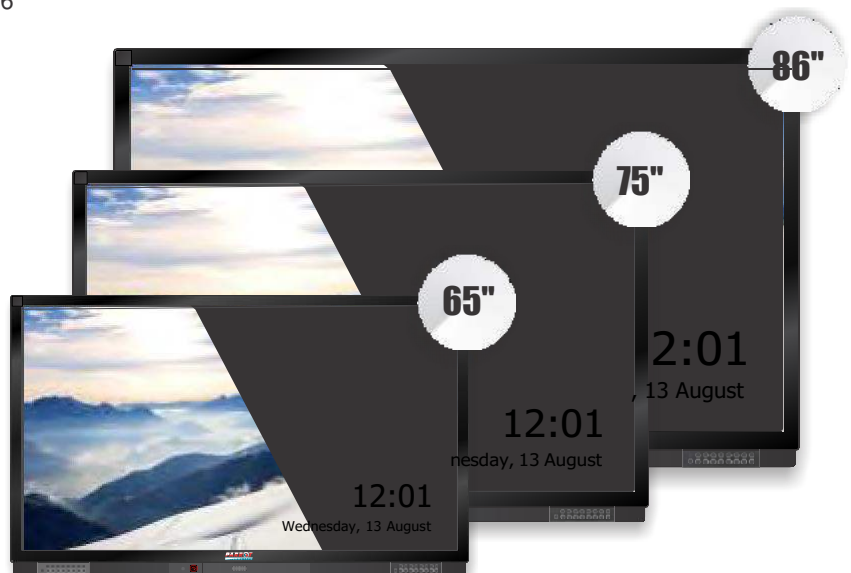

Interactive Whiteboards



| Code | Description | Size |
|----------|------------------------------------|---------------------|
| HV-1683 | Multi-Touch Interactive Whiteboard | 78" 1,571 x 1,178mm |
| HV-16103 | Multi-Touch Interactive Whiteboard | 98" 2,176 x 1,326mm |

- Technology: IR (infra-red).
- Aspect Ratio: 4:3 / 16:10
- Multi-Touch Point: 10 Points.
- Input: Finger or Pen.
- Touch Accuracy: 1mm.
- Connection Type: USB Cable.
- USB Type: A (Client) -B (IWB).
- USB Length in standard package: 5m.
- Driver Support OS: Win 7 / 8 / 10.
- MAC and Linux: Drivers available on request.

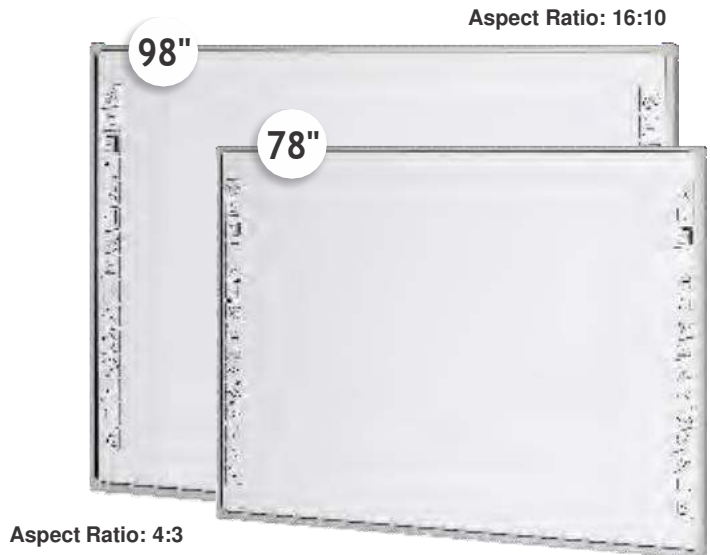

Only Suitable for use with Parrot Whiteboard Markers
Wet erase recommended



BA0201



PW0601A



BA0110

Product Includes:



Non-reflective Whiteboard



| Code | Description | Size |
|--------|--|---------------|
| IW1063 | Non-Reflective Whiteboard For Interactive System | 1620 x 1220mm |

- Can be used with the Parrot IWB system (IW1000)

Custom non - reflective available *limit size* of 3000mm x 1200mm

Provides a low glare surface and quality visuals, when used with short or long throw projectors

Seamless transition between projection and writing



Only Suitable for use with Parrot Whiteboard Markers
Wet erase only



BA0201



PW0601A



BA0110

Stands

Interactive Touch LED Stand

Code Description

| | |
|--------|--|
| IW7101 | Interactive Touch Led Stand |
| IW7102 | Interactive Touch Panel Mobile Stand Grey |
| IW7103 | Interactive Touch Panel Mobile Stand White |

* Excludes Interactive Touch LED Panel



Coming Soon

IW7102



- Mobile Castor Stand
- Powder Coated
- Max Load Capacity 57.6kg
- Easy assembly
- Built in Cable management
- Perfect for TV's and Touch Screens

IW7103



- Mobile Steel Castor Stand
- Adjustable screen/board sizes 42"-98"
- Max Load Capacity 160kg
- Easy assembly
- Perfect for TV's, Touch Screen and Interactive Whiteboards

Interactive Whiteboard Stand on Castors

Code Description

| | |
|--------|---|
| IW2051 | Interactive Whiteboard Stand on Castors |
|--------|---|

- Compatible with all Parrot interactive whiteboards
- Fits through a standard door frame
- Maximum weight: 60kg
- Frame Width:
 - Minimum Width: 32mm
 - Maximum Width: 42mm
- Light weight
- Stylish aluminium design
- Lockable castors

* Excludes Interactive Whiteboard

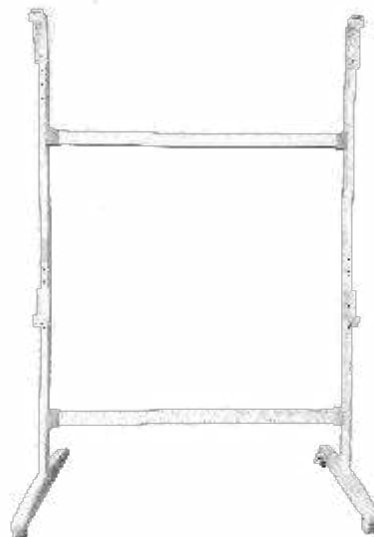

Long Throw



Short Throw



Enquire about our range of latest short throw
or long throw data projectors

** Models may vary*

DLP/LCD Ceiling Mounting Bracket / Projector Security Cage

| Code | Description | Size |
|---------|--|-------------------|
| OP0300 | Ceiling Mount Bracket Projector | 400 - 650mm |
| OP0301 | Ceiling Mount Projector Security Cage | 450 x 220 x 340mm |
| OP0302 | Ceiling Mount Bracket Projector | 52mm |
| OP0310* | Ceiling Mount Bracket Projector Lockable | 430 - 650mm |
| OP0312* | Ceiling Mount Bracket Projector Lockable | 62mm |
| OP0330 | Ceiling Mount Bracket Extension | 1800mm |
| OP0331 | Ceiling Mount Bracket Extension | 900mm |
| OP0343 | Wall Mount Bracket Projector Adjustable | 820 - 1200mm |

- Projector not included
- Universal projector mounts
- Adjustable tilt and height on OP0300 & OP0310

- * Cable management system
- * Security System

OP0302

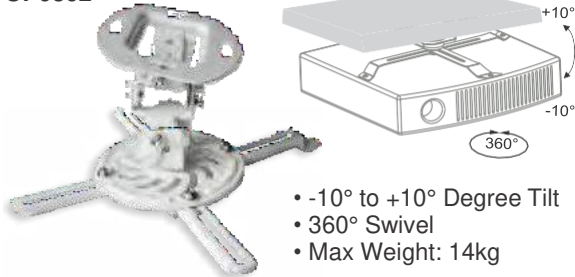

OP0343

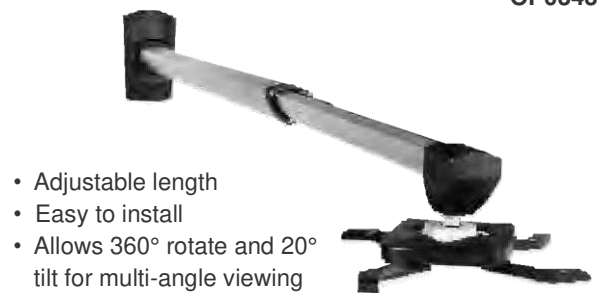

OP0300

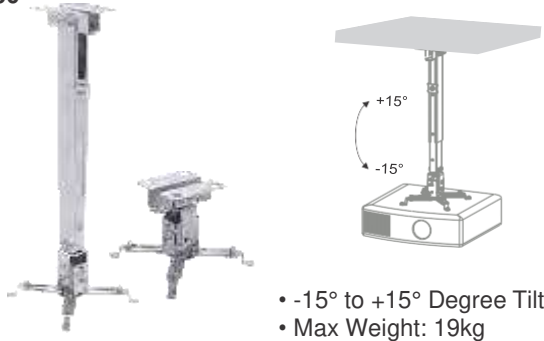

OP0301



- Lockable
- Ceiling mounted
- Universal size to fit most Projectors (450*220*340mm)
- Not suitable for small LED Projectors
- White powder coated steel
- Height adjustable: 465 to 815mm
- Mounting accessories included
- Supplied with 3 x Pad Lock and 6 Keys
- Data Projector not included

* Model may vary from image

OP0310



*** While stocks last**

Data Projector Trolleys

| Code | Description | Size |
|--------|---------------------------------|--------------------|
| OP1052 | Data Projector & Laptop Trolley | 1000 x 880 x 620mm |

Product Features

- Angle-adjustable top
- Lockable castors



Screen Ratios

Which ratio screen suits you?

1:1 Ratio screens are ideal for square projections such as Overhead Projectors.

4:3 Ratio screens are sized for a computer monitor and work ideally with DLP/LCD Projectors.

16:9 Ratio screens are formatted for modern video in cinematic format.



Projector Screens

Pulldown



1:1 Ratio

| Code | Description | Size | Viewing Area |
|--------|---------------------|---------------|---------------|
| SC0252 | Screen Pulldown PVC | 1270 x 1270mm | 1220 x 1220mm |
| SC0265 | Screen Pulldown PVC | 1520 x 1520mm | 1470 x 1470mm |
| SC0269 | Screen Pulldown PVC | 1830 x 1830mm | 1780 x 1780mm |
| SC0271 | Screen Pulldown PVC | 2130 x 2130mm | 2030 x 2030mm |
| SC0278 | Screen Pulldown PVC | 2440 x 2440mm | 2340 x 2340mm |
| SC0287 | Screen Pulldown PVC | 3050 x 3050mm | 2950 x 2950mm |

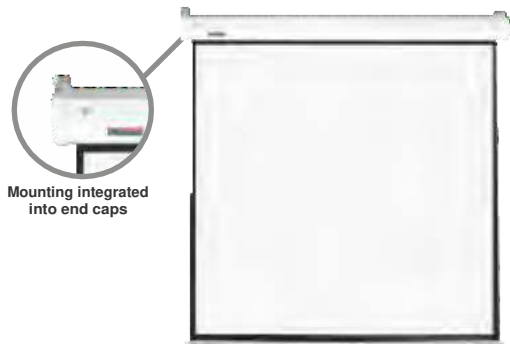

4:3 Ratio

| Code | Description | Size | Viewing Area |
|--------|---------------------|---------------|---------------|
| SC0273 | Screen Pulldown PVC | 1760 x 1330mm | 1710 x 1280mm |
| SC0274 | Screen Pulldown PVC | 2110 x 1600mm | 2030 x 1520mm |
| SC0275 | Screen Pulldown PVC | 2440 x 1850mm | 2340 x 1750mm |
| SC0285 | Screen Pulldown PVC | 3050 x 2310mm | 2950 x 2210mm |

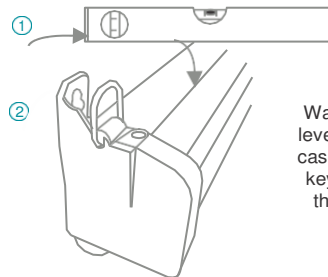

Wall screens must be mounted level ① and with the back of the case parallel to the wall. Use the keyhole slot ② at the back of the hanging bracket for flush wall mounting.

16:9 Ratio

| Code | Description | Size | Viewing Area |
|--------|---------------------|---------------|---------------|
| SC0068 | Screen Pulldown PVC | 1870 x 1050mm | 1770 x 950mm |
| SC0074 | Screen Pulldown PVC | 2450 x 1420mm | 2350 x 1320mm |
| SC0080 | Screen Pulldown PVC | 3040 x 1760mm | 2940 x 1660mm |

- Self-locking system is easy to use.
- Screen stays wrinkle-free, is flame retardant and mildew resistant.
- Black framed, black backed screen.



1:1 Ratio

| Code | Description | Size | Viewing Area |
|--------|---------------|---------------|---------------|
| SC0152 | Screen Tripod | 1270 x 1270mm | 1220 x 1220mm |
| SC0165 | Screen Tripod | 1520 x 1520mm | 1470 x 1470mm |
| SC0169 | Screen Tripod | 1830 x 1830mm | 1780 x 1780mm |
| SC0171 | Screen Tripod | 2130 x 2130mm | 2030 x 2030mm |

4:3 Ratio

| Code | Description | Size | Viewing Area |
|--------|---------------|---------------|---------------|
| SC0173 | Screen Tripod | 1760 x 1330mm | 1710 x 1280mm |
| SC0174 | Screen Tripod | 2110 x 1600mm | 2030 x 1520mm |
| SC0175 | Screen Tripod | 2440 x 1850mm | 2340 x 1750mm |

16:9 Ratio

| Code | Description | Size | Viewing Area |
|--------|---------------|---------------|---------------|
| SC0474 | Screen Tripod | 2450 x 1420mm | 2350 x 1320mm |



Keystone bracket



Bottom casing roll up



Tripod feet

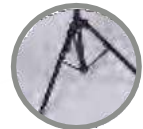

- The adjustable stand allows various heights suitable for every need.
- The screen hook has different angle positions for keystone adjustment.
- Black-framed, black-backed screen.

Projector Screens

Electric

1:1 Ratio

| Code | Description | Size | Viewing Area |
|--------|-----------------|---------------|---------------|
| SC0369 | Screen Electric | 1830 x 1830mm | 1780 x 1780mm |
| SC0378 | Screen Electric | 2440 x 2440mm | 2340 x 2340mm |
| SC0387 | Screen Electric | 3050 x 3050mm | 2950 x 2950mm |

4:3 Ratio

| Code | Description | Size | Viewing Area |
|--------|-----------------|---------------|---------------|
| SC0374 | Screen Electric | 2110 x 1600mm | 2030 x 1520mm |
| SC0375 | Screen Electric | 2440 x 1830mm | 2340 x 1750mm |
| SC0385 | Screen Electric | 3050 x 2310mm | 2950 x 2210mm |

16:9 Ratio

| Code | Description | Size | Viewing Area |
|---------|-----------------|---------------|---------------|
| SC0568* | Screen Electric | 1870 x 1110mm | 1770 x 1000mm |
| SC0574 | Screen Electric | 2440 x 1420mm | 2340 x 1320mm |
| SC0579 | Screen Electric | 2730 x 1580mm | 2630 x 1430mm |



Remote control

- Remote and wall-mounted controls included.
- The motor is quiet, secure and precise.
- The screen stays wrinkle-free, is flame-retardant and mildew-resistant.
- Black-framed, black-backed screen.

* While stocks last



Keystone Adjusters

| Code | Description | Size |
|--------|---------------------------------------|-------|
| SC0400 | Keystone Brackets Adjustable Set of 2 | 300mm |

- Recommended when using Overhead Projectors.
- Ideal for Pulldown Screens.



See page 82 For Projectors

Ceiling Box

Code Description

Width of Screen

Space Required for Ceiling Box

| | | | |
|--------|-------------------------------------|---------------------------|-----------|
| SC0652 | Ceiling Box Recessed to fit screens | A: 1270mm width of screen | B: 1670mm |
| SC0665 | Ceiling Box Recessed to fit screens | A: 1520mm width of screen | B: 1920mm |
| SC0669 | Ceiling Box Recessed to fit screens | A: 1830mm width of screen | B: 2230mm |
| SC0675 | Ceiling Box Recessed to fit screens | A: 2130mm width of screen | B: 2530mm |
| SC0678 | Ceiling Box Recessed to fit screens | A: 2440mm width of screen | B: 2840mm |
| SC0679 | Ceiling Box Recessed to fit screens | A: 3050mm width of screen | B: 3520mm |
| SC0683 | Ceiling Box Recessed to fit screens | A: 3620mm width of screen | B: 4120mm |

- Conceals screen within the ceiling.
- Recommended for Electric Screens.
- Aluminium extruded box with plastic end caps.

*** While stocks last**

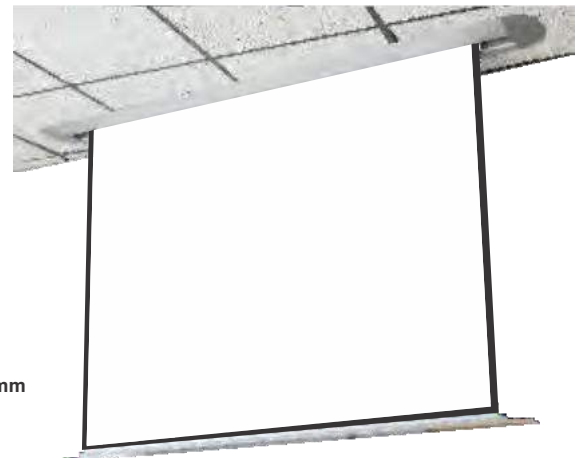
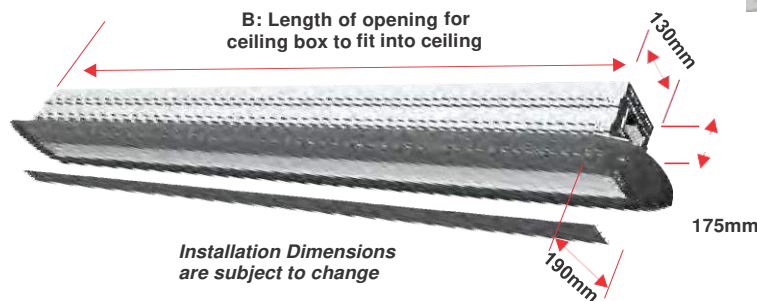

Laser Pointers

Laser Pointer Presenter USB2.0, Pen & Batteries

Code Description

| | |
|--------|---|
| EL1002 | Laser Pointer Stylus |
| EL1005 | Laser Pointer Presenter USB 2.0 Red Laser |

EL1002 Laser Pointer Stylus

- Ideal for presentations
- Integrated mini flashlight and stylus nib
- Black ball point pen
- Red laser light
- Requires 3 x AG3 batteries (not included)



EL1002

Laser Pointer Presenter USB 2.0 Red Laser

EL1005 Laser Pointer Presenter USB2.0

- Laser Pointer Presenter USB 2.0 Red Laser - red laser pointer, page up page down buttons, USB 2.0 connection, plug & play.
- 1 x AAA battery for up to 10 hours use (Included)
- Working distance 10m



EL1005

Monitor Clamp Brackets



Code Description

AL6001 Bracket Monitor Clamp Single Arm With Gas Spring

Code Description

AL6002 Bracket Monitor Clamp Dual Arm With Gas Spring

Code Description

AL6003 Bracket Monitor Clamp Triple Arm With Gas Spring



Features:

- Single monitor clamp
- Fits most 17" - 32" flat & curved monitors
- Built-in spring tension gauge & gas spring
- 75 x 75 or 100 x 100 VESA compatible
- 40 degree tilt / 360 degree rotation
- Cable management
- Weight capacity: 1 - 9kg (per arm)

Features:

- Dual monitor clamp
- Fits most 17" - 32" flat & curved monitors
- Built-in spring tension gauge & gas spring
- 75 x 75 or 100 x 100 VESA compatible
- 40 degree tilt / 360 degree rotation
- Cable Management
- Weight capacity: 1 - 9kg (per arm)

Features:

- Triple monitor clamp
- Fits most 17" - 32" flat & curved monitors
- Built-in spring tension gauge & gas spring
- 75 x 75 or 100 x 100 VESA compatible
- 40 degree tilt / 360 degree rotation
- Cable management
- Weight capacity: 1 - 7kg (per arm)



Mini, Econo & Deluxe Tripods

Code **Description**
AL6100 Tripod - Desktop Mini 130mm



- Features:**
- Lightweight & portable
 - Easy to use
 - Compact mounting solution
 - Suitable for digital cameras, webcams & mobile phones (Not included)

Code **Description**
AL6110 Tripod - Econo 1350mm



- Features:**
- Multi-purpose head with quick release
 - Secure mounting plate
 - 3-way pan head
 - 3-section telescopic legs
 - Built-in bubble level
 - Flip lock legs

Code **Description**
AL6120 Tripod Deluxe 1570mm



- Features:**
- Ideal for professional use
 - Built-in ball head
 - Secure mounting plate
 - 4-section telescopic legs
 - Tripod legs with twist lock
 - Easily converts to a monopod

Brackets

| Code | Description | Size |
|--------|-----------------------------------|-------|
| AL4001 | Tablet Secured Stand Universal | 10.1" |
| AL0131 | Motion TV Wall Mount Economy Full | |
| AL0132 | Motion TV Wall 60" - 100" Full | |
| AL0133 | Flat Mount 60" - 100" | |
| AL0134 | Flat Mount 37" - 80" | |



AL4001

- Height-adjustable aluminium tube
- Retractable leg
- Multiple display angles, rotates 360°



AL0133

- Slim design, distance to the wall is 32mm
- Supports TV's between 60" – 100"

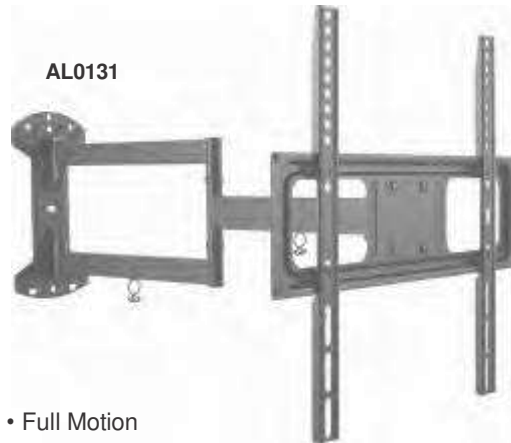

AL0131

- Full Motion
- Fits most TV's: 32" - 55"
- Side to side swivelling



AL0132

- Swiveling arm offers maximum viewing
- Cable management system
- Supports TV's between 60" – 100"

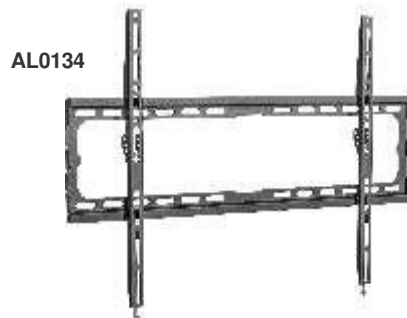

AL0134

- Slim design, distance to the wall is 20mm
- Supports TV's between 37" – 80"

Security Cable

| Code | Description |
|--------|-------------------------------|
| AL6200 | Remote Control Security Cable |

- Ideal for use in conference, meeting or education rooms and retail stores.
- Protective anti-theft solution for remote controls / Prevents lost, stolen or misplaced remote controls
- Includes adhesive backing - easy to install
- 950mm retractable steel cord



AL6200

Graphics Tablet Wired



Code Description

GT1060P Graphics Tablet Wired 10 x 6"

- Unleashing digital creativity
- Enhance work flow and photo editing accuracy
- Battery-Free pressure pen
- Sample rate: 233 PPS USB interface
- Resolution: 5080 LPI
- Active height: 15mm
- Built-in driver
- Multiple drawing program support
- Pressure sensitivity: 8192 levels
- Active drawing area: 10 x 6.25 inches



Included in package:

- 1 x Pressure pen
- User Manual
- 8 x Spare Nibs
- 1 x Nib Clip



Plug & Play

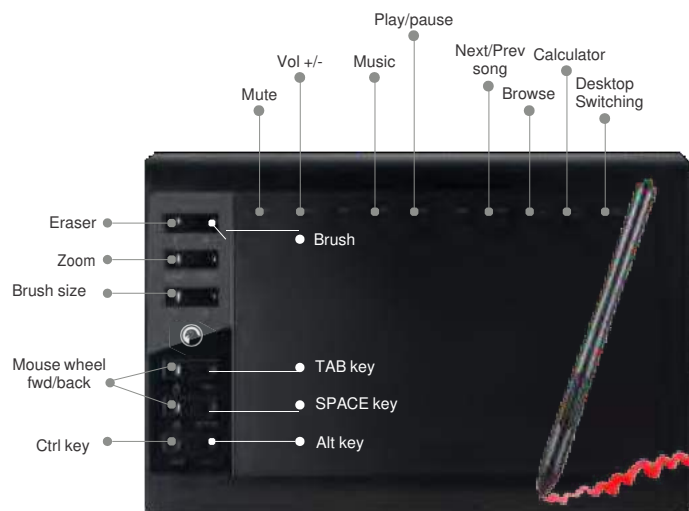

Air Mouse

Code Description

IWC3001 Air Mouse Wireless Keyboard

- High precision 6-axis Gyroscope
- Perfect for Home and Office use
- Air Mouse with Wireless QWERTY Keyboard
- Supports: Android, Windows, Mac OS and Linux
- Supports motion-sensing gaming
- Connects with most devices via 2.4GHz wireless
- Up to 10m distance range
- Compatible with: Smart TV's, Computers, Game Consoles and Tablets



Due to continuous technological improvements, models may be upgraded prior to Catalogue reprint.



Wireless Keyboard & Mouse

Code Description

IC0003 Wireless Keyboard & Mouse

- High quality design
 - Plug and Play, no driver needed
 - 2.4GHz wireless ultra-thin keyboard mouse combo
 - Low-profile keys
 - Portable mouse with unifying receiver
 - 10m wireless transmission distance
 - Resolution: 1000DPI Batteries:
 - Mouse: 1xAA***
 - Keyboard: 1xAA***
- ***Batteries not included



Speaker Sound Bar

Code Description

CT3006 Speaker Sound Bar

CT3006

- LED display and remote control
- Bluetooth 3.0
- 2.1 Channel Sound Bar
- RMS: 35W = 2 x 10w + 15w (80db)
- Wall mountable (brackets and screws not included)
- The perfect entry level Sound Bar

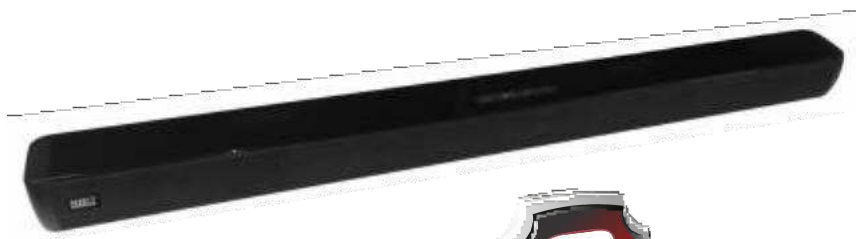



Speaker Sound Bar

Code Description

CT3017 Speaker Sound Bar Econo

- Sleek & elegant design
- High-end audio experience
- 2.0 Surround sound
- Built-In subwoofer
- Enhanced dual bass ports
- 3 Equalizer modes



Code Description

CT3018 Parrot Speaker Sound Bar + 5,25 Inch Wireless Sub

- Sleek & elegant design
- High-end audio experience
- 2.1 Surround sound
- Wireless subwoofer
- Enhanced dual bass ports
- 3 Equalizer modes



Audio Devices

Bluetooth Earphone

Code Description

CT3010 Wireless Bluetooth Earphones

- Built-in Microphone
- iOS battery display
- Supports HD Voice
- Bluetooth: V4.1 + EDR
- Operating Range: 10m
- Standby Time: 1.5hrs
- Talk/Playing Time: 7hrs
- Charging Port: Micro USB



Soft Ear Hooks



HD Sound & Bass



Hands-Free



Battery Time: +5hrs



Wired Earphones

Code Description

CT3014 Audio - Wired Earphones

- Perfect for sports use
- Ergonomic 45° Design
- Multi-function three button control
- Compatible with most devices



Built-in Mic



3.5mm Audio Jack



HD Sound Quality



Mobile Bluetooth Speaker

Code Description

CT3011 Mobile Bluetooth Speaker

- Noise Ratio: ≥ 80 DB
- Distortion: THD=1%
- Music Format: MP3 WAV
- Bluetooth: V4.1 + EDR
- Operating Range: 10m
- Battery Operating Time: 6-12hrs
- Charging Port: Micro USB
- Built-In Powerbank - 4500 mA



Hands-Free Call



Max Output: 16W



Call Centre Wired Headset

Code Description

CT4001 Call Centre Wired Headset

- Plug & Play
- Noise cancellation mic
- Binaural for immersive, high quality sound
- Flexible boom arm
- Soft protein ear pads
- Dual connection options: USB or 3.5mm Audio
- 90° Rotating ear cups



Call Centre Wireless Mono

Coming Soon

Code Description

CT4002 Call Centre Headset Wireless Mono

- Wireless bluetooth headset
- Noise cancelling
- 30 Hours talk time battery life
- 10 meter operation range
- 2 Hour charge time
- Rotatable microphone turns to be used either on the left or right-hand side
- Bluetooth V5.0
- Nett weight: 79g



Wired Headphones

Code Description

CT3012 Wired Headphones
CT3013 Wired Headphones Pro

- HD sound quality
- 6.3mm & 3.5mm Audio Jack inputs
- 90° rotating ear cups
- 2m - 3m stretch coiled cable
- Adjustable head band
- Noise isolation earcup



CT3012



CT3013

Bluetooth Headphones

Code Description

CT3016 Bluetooth Headphones

- HD sound quality
- 6.3mm & 3.5mm Audio Jack inputs
- 2m - 3m stretch coiled cable
- Adjustable head band
- 12m wireless range
- Up to 20hrs talk time
- Bluetooth 5.0
- Premium tuned sound quality



Acoustic Panel



Coming Soon

Code Description

| | |
|----------|---|
| AP3030B | Acoustic Panel 300 x 300mm Pyramid - Black |
| AP3030L | Acoustic Panel 300 x 300mm Pyramid - Dark Grey |
| AP3030LG | Acoustic Panel 300 x 300mm Pyramid - Light Grey |

- Excellent solution for reducing unwanted reverberation and echo in a room
- Ideal for home theatres, offices, board rooms, restaurants, classrooms and recording studios
- 12 panels (1.08sqm)
Individual Panel size: 300 x 300mm
- Fire Resistant Polyurethane foam
- Available in Black, light grey and dark grey
- Easy to install
Self-adhesive backing
- Stylish pyramid design
- 25Kgs/M3 High Density
- Prevent echoes inside a room
- Noise reduction



Pyramid Shaped Foam



Acoustic Enhancement



Noise Reduction

Lectern & Wireless Mic



Code Description

LE1001 Lectern with Microphone

- One gooseneck mic and one lamp
- Built-in 60W amplifier
- One line input, two microphone inputs
- One line output, one record output
- Signal transmission distance max 100 meters
- Dimensions (L x W x H): 580 x 420 x 1100mm

**Compatible with the Wireless Lapel Mic*



Back

Front

Wireless Lapel Mic

Code Description

IS1002 Wireless Lapel Mic
(Dual-channel UHF wireless Technology)

- Professional recording quality
- Professional-level LOW-CUT & mixing function
- Real-time fold back interface for monitoring recording effects
- The volume of monitoring and recording output can be adjusted independently and has memory function
- High-performance audio compression expander provides wider audio dynamic response
- Dual-channel UHF wireless receiving technology, for simultaneous use of 2 transmitters



Video Conference Camera



Code Description

VC1080C Video Conference Camera - FHD 1080P
 VC1080CM Conferencing Camera Mounting Bracket

- 355° Horizontal Pan
- Unique 60° Tilt Range
- 1/2.8" Progressive CMOS
- IR Remote Controller Included
- Installation methods:
 Wall mountable, Freestanding
 Ceiling mountable
- Integrated & delicate design



VC1080C



VC1080CM

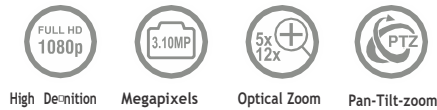

Video Conference Speaker Microphone

Code Description

VC1080M Wired Speaker Microphone
 VC1080W Wireless Speaker Microphone

- Firm and compact structural design
- Remarkable voice quality
- Dynamic noise reduction
- Duplex audio technology
- USB 2.0
- Cardioid microphone



VC1080M



VC1080W



- Wireless connectivity 2.4 Ghz
- Wireless range of 10 - 15 meters

Video Conference Webcam

Code Description

VC0001 Video Conference Webcam Full HD

- Resolution: 1920 x 1080p
- Video mode: 24bit true colour
- Interface: USB port
- Manual focus
- Automatic light enhancement
- Built-in noise reduction microphone
- Optical glass lens
- Multi-purpose base



Code Description

VC0003 Video Conference Wide Angle 100 Degree Webcam 4k

- 1/2.8 inch high quality 4K CMOS sensor
- 8.28MP 16:9
- 2x Built - in mic pickup
- 3x Digital zoom
- Manual focus
- White balance auto / manual
- Exposure auto / manual



Desktop USB Microphone

Code Description

IS1003 Desktop USB Microphone

- High quality sound
- Ideal for recording and live streaming
- Reduces background noise
- Unidirectional microphone
- Includes table top stand



See page 78 - 80 for Interactive Whiteboards and LED Panels

Wireless Presentation

Code Description

| | |
|------------|-------------------------------------|
| MTC-4500 | Wireless Presentation Unit |
| MTC-4500BH | Wireless Presentation Unit + Dongle |
| MTC-4500H | Wireless Presentation Dongle |

MTC-4500H

- HDMI Dongle for effortless plug & play connectivity to MTC-4500



MTC-4500

- Wireless presentation tool for collaboration and file sharing
- Allows 16 users to connect PC's or tablet devices with 4 devices to mirror as main screens
- offers annotation and whiteboard tool to enhance collaboration



MTC-4500H

Visualizers

Code Description

| | |
|--------|-----------------------------|
| VZ0001 | Visualizer Presenter Econo |
| VZ0002 | Visualizer Presenter Deluxe |

VZ0001

- Auto Focus
- 5 x Digital zoom
- 8 Megapixel
- 30fps focus
- USB or DC Power Connection
- USB Output
- Built-in LED Light
- Built-in Mic

VZ0002

- Auto Focus
- 100 x Digital zoom
- 8 Megapixel
- Full HDMI
- 30fps focus
- VGA, HDMI & USB Outputs
- SD Card reader for storing video
- Built-in LED Light
- Built-in Mic



Supports:



External Storage



Code

Description

| | |
|---------|---|
| XT0032 | External Storage USB 3 Type A + USB C 32GB Flash Drive |
| XT0064 | External Storage USB 3 Type A + USB C 64GB Flash Drive |
| XT00128 | External Storage USB 3 Type A + USB C 128GB Flash Drive |

- High Speed USB 3
- Dual USB Type A and USB type C
- Allows you to easily transfer files from smart phones, tablets and PCs
- 25Mbps write speed
- 80Mbps Read speed
- Transfer speed of up to 150Mbps



Code

Description

| | |
|--------|---|
| XT2256 | External Storage M.2 Sata Portable Type C 256GB |
| XT2500 | External Storage M.2 Sata Portable Type C 500GB |

- M.2 SATA portable type C
- Read/Write speed: 256Mbps / 500Mbps
- Storage capacity: 256GB / 500GB
- Metal casing
- Dimensions: 12.3*3.3*0.6cm
- Net Weight: 40.1g



Cables

Code Description

| | |
|---------|---|
| CL1002 | HDMI 2m |
| CL1002A | HDMI 180 Degree Rotatable 1.8m |
| CL1002B | HDMI Male to Micro HDMI 2m |
| CL1005 | HDMI 5m |
| CL1010 | HDMI 10m |
| CL1020 | HDMI 20m |
| CL2002 | USB 2.0 A Male To A Male 1.8m |
| CL2002B | USB 3.0 CM to AM 2m |
| CL2003B | USB 3.0 CM to AM 3m |
| CL2010A | USB 2.0 Extension 10m |
| CL2010B | USB 2.0 Active Extension 10m |
| CL2020A | USB 2.0 AM to BM 20m |
| CL3002 | CAT6 Network - 2m |
| CL3005 | CAT6 Network - 5m |
| CL3010 | CAT6 Network - 10m |
| CL3020 | CAT6 Network - 20m |
| CL4002 | 3.5MM Jack - Jack 1.8m |
| CL4002A | 3.5MM Jack - Two Male RCA 1.8m |
| CL4010 | 3.5MM Jack - Jack 10m |
| CL4010A | 3.5MM Jack - Two Male RCA 10m |
| CL4020 | 3.5MM Jack - Jack 20m |
| CL4020A | 3.5MM Jack - Two Male RCA 20m |
| AC1001 | Plug - 6 x 16A SA & 5 x Euro and 1 X Schucko Extender |
| AC1008 | Plug - 3 x 16A SA & 3 x Euro Extender |
| AC1009 | Plug - RSA Twin Euro Adaptor |
| AC1010 | Plug - 1 x 16A SA & 2 X Euro and 1 x Schucko Socket Adaptor |
| CL1030 | Cable - HDMI 8k Fibre 2,1 Cable 30 Meter |
| CL1050 | Cable - HDMI 8k Fibre 2,1 Cable 50 Meter |
| CON0001 | Conduit Aluminium 22 x 11 x 2900mm |

HDMI Fibre Cables



HDMI Cables



HDMI 180 Degree Rotatable



Power Plugs & Cables



USB Cables



Conduit Aluminium



Audio Cables



Network Cables



Include colour code when ordering
Available colours - ex stock:
Colour codes: Mill(M), Grey(G),
White(W), Special(S)

Adaptors

Code Description

| | |
|--------|---|
| AD1001 | 90 Degrees 3.5mm Jack |
| AD1002 | 3.5mm Stereo Male to 2x Stereo Female |
| AD2003 | Male for 15 Pin Female to Female VGA |
| AD2004 | Lindy HDMI Female to Mini HDMI Male |
| AD2005 | HDMI Switch 3 to 1 |
| AD2006 | HDMI Switch 5 to 1 |
| AD2008 | HDMI to VGA with Audio |
| AD2010 | 1 To 2 HDMI Splitter |
| AD2011 | 1 To 4 HDMI Splitter |
| AD2012 | 1 To 8 HDMI Splitter |
| AD2013 | HDMI Extender by CAT5/6 up to 30m |
| AD2015 | Display Port to HDMI |
| AD2016 | Display Port Male to VGA Female |
| AD2017 | HDMI Female to HDMI Female |
| AD2018 | Adaptor - USB C Male to USB B Female |
| AD2019 | Adaptor - USB C to HDMI Converter |
| AD2020 | Adaptor - USB C Male to 3,5mm Female Audio Jack |
| AD2021 | Adaptor - 3.5mm Male to 3,5mm Female Audio Jack |
| AD3001 | USB Extender over CAT5/6 |
| AD3002 | 4 Port USB2.0 Hub |
| AD3003 | 4 Port USB3.0 Hub |
| AD3004 | Adaptor - USB C Hub 7 in 1 |

HDMI Extender



Display Adaptor



15 Pin Female to Female VGA adaptor



USB C Male to 3.5mm Female jack



Female to Male HDMI



HDMI to VGA With Audio

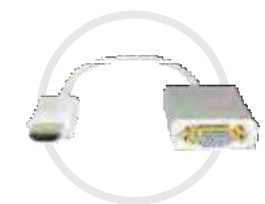

Rj45 Over CAT5E .CAT6E USB Extender



4 Port USB Hub





Digital displays with advertising feature benefits such as web connectivity & high-definition displays which combine vivid colours that attract attention. Easily updatable with the ability to provide audiences with engaging information that ensures dynamic and visible content.

Outdoor Cabinets

| Code | Description | Size |
|----------|--------------------------|-------------|
| DSP5-640 | Digital Sign – Parrot P5 | 640 x 640mm |
| DSP8-960 | Digital Sign – Parrot P8 | 960 x 960mm |

Indoor Cabinets

| Code | Description | Size |
|----------|------------------------------|-------------|
| DSP4-512 | Digital Sign – Parrot P3.9 | 500 x 500mm |
| DSP2-480 | Digital Sign – Parrot P1.875 | 540 x 480mm |

High definition displays for indoor & outdoor use

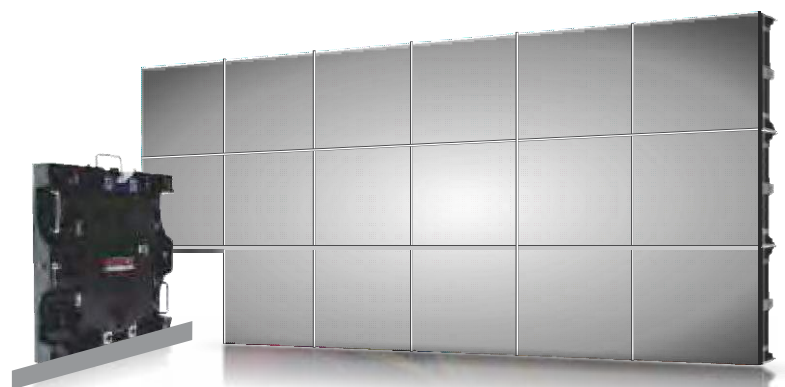

* Pictures shown are for illustration purpose only. Actual product may vary.

LED Modular Display



Mitred Econo Frame

| Code | Description | Poster Size | Size |
|--------|------------------------|--------------|--------------|
| BG3200 | A0 Single Mitred Econo | 1189 x 841mm | 1230 x 870mm |
| BG3201 | A1 Single Mitred Econo | 841 x 594mm | 870 x 625mm |
| BG3202 | A2 Single Mitred Econo | 594 x 420mm | 625 x 450mm |
| BG3203 | A3 Single Mitred Econo | 420 x 297mm | 450 x 330mm |
| BG3204 | A4 Single Mitred Econo | 297 x 210mm | 330 x 240mm |

- Mitred corner.
- Aluminium frame 23mm wide.
- Spring action frame.
- Quick and easy poster display change.
- Mounting screws and wall plugs included.
- Non-reflective media cover supplied - see page 108 clear media cover options.



Mitred Corner

| Code | Description | Poster Size | Size |
|---------|-----------------|--------------|--------------|
| BG1000 | A0 Single Sided | 1189 x 841mm | 1250 x 900mm |
| BG1001 | A1 Single Sided | 841 x 594mm | 900 x 655mm |
| BG1002 | A2 Single Sided | 594 x 420mm | 655 x 480mm |
| BG1003 | A3 Single Sided | 420 x 297mm | 480 x 360mm |
| BG1004 | A4 Single Sided | 297 x 210mm | 335 x 230mm |
| BG2000* | A0 Double Sided | 1189 x 841mm | 1250 x 900mm |
| BG2001* | A1 Double Sided | 841 x 594mm | 900 x 655mm |
| BG2002* | A2 Double Sided | 594 x 420mm | 655 x 480mm |
| BG2003* | A3 Double Sided | 420 x 297mm | 480 x 360mm |
| BG2004* | A4 Double Sided | 297 x 210mm | 360 x 270mm |

- Mitred corner.
- 32mm Frame
- UV resistant media cover
- Weather resistant
- High Quality Frame
- Spring action frame
- Mounting screws and wall plugs included for single sided Poster Frames only.



Available double & single sided

* Poster frame can be made to order



Spring action Aluminium

*** While stocks last**

Plastic Corner

| Code | Description | Poster Size | Size |
|--------|-------------------|-------------|-------------|
| BG3101 | A1 Plastic Corner | 841 x 594mm | 900 x 655mm |
| BG3102 | A2 Plastic Corner | 594 x 420mm | 655 x 480mm |
| BG3103 | A3 Plastic Corner | 420 x 297mm | 480 x 360mm |
| BG3104 | A4 Plastic Corner | 297 x 210mm | 360 x 270mm |

- Grey matte plastic corner
- Aluminium frame 25mm wide
- Quick and easy Poster display change
- Mounting screws and wall plugs included
- UV resistant media cover
- Weather resistant
- High Quality Frame
- Spring action frame

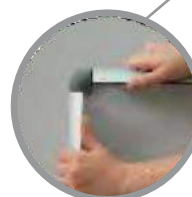

Spring action frame * Poster frame can be made to order

While stocks last

Poster Frames

Chrome Corner

| Code | Description | Poster Size | Size |
|--------|------------------|--------------|--------------|
| BG3000 | A0 Chrome Corner | 1250 x 900mm | 1189 x 841mm |
| BG3001 | A1 Chrome Corner | 900 x 655mm | 841 x 594mm |
| BG3002 | A2 Chrome Corner | 655 x 480mm | 594 x 420mm |
| BG3003 | A3 Chrome Corner | 480 x 360mm | 420 x 297mm |
| BG3004 | A4 Chrome Corner | 360 x 270mm | 297 x 210mm |

- Chrome plated plastic corner
- Aluminium frame 33mm wide
- Spring action frame
- Quick and easy Poster display change
- Mounting screws and wall plugs included
- Non-reflective media cover supplied
 - see additional 108 clear media cover options
- UV resistant media cover
- Weather resistant
- High Quality Frame



Spring action Frame



* Poster frame can be made to order

Security Frames

| Code | Description | Poster Size | Size |
|--------|-----------------|-------------|-------------|
| BG1103 | A3 Single Sided | 420 x 297mm | 450 x 327mm |
| BG1104 | A4 Single Sided | 297 x 210mm | 327 x 240mm |

- Mitred corner
- Aluminium frame 25mm wide
- Secure profile
- Weather resistant
- Quick and easy poster display change
- Includes screws and wall plugs
- Supplied with unlocking tool
- Non-reflective media cover supplied
 - see page 108 clear media cover options



Double Sided Window Poster Frames

| Code | Description | Poster Size | Size |
|--------|-----------------|-------------|-------------|
| BG1203 | A3 Double Sided | 450 x 327mm | 420 x 297mm |
| BG1204 | A4 Double Sided | 327 x 240mm | 297 x 210mm |

- Mitred corner
- Aluminium frame 25mm wide
- Spring action frame
- Quick and easy poster display change
- Double sided tape included for mounting
- Non-reflective media cover supplied

While stocks last



Double Sided, Self-adhesive Magnetic Poster Frame - Flexi

| Code | Description | Size |
|--------|--------------------------------------|------|
| BG4103 | Poster Frame, Magnetic Self Adhesive | A3 |
| BG4104 | Poster Frame, Magnetic Self Adhesive | A4 |

- Ideal for use on windows or clear surfaces
- Scratch-resistant
- Portrait or landscape
- Simple and stylish
- Clear self-adhesive mounting
- Double-sided poster display

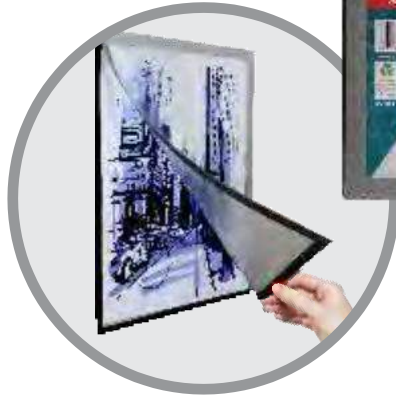

Poster Frame Clear Media Cover

| Code | Description | Size |
|--------|------------------------|--------------------|
| BG0000 | Media Cover A0 (Clear) | 1189 x 841 x 1.2mm |
| BG0001 | Media Cover A1 (Clear) | 841 x 594 x 1.2mm |
| BG0002 | Media Cover A2 (Clear) | 594 x 420 x 1.2mm |
| BG0003 | Media Cover A3 (Clear) | 297 x 420 x 1.2mm |
| BG0004 | Media Cover A4 (Clear) | 297 x 210 x 1.2mm |

- Durable.
- Plexiglass thickness 1.2mm.
- Poster Frames not included.
- Clear reflective surface.
- UV resistant.



Poster Frames Supports

Poster Frame Stand - Double Sided

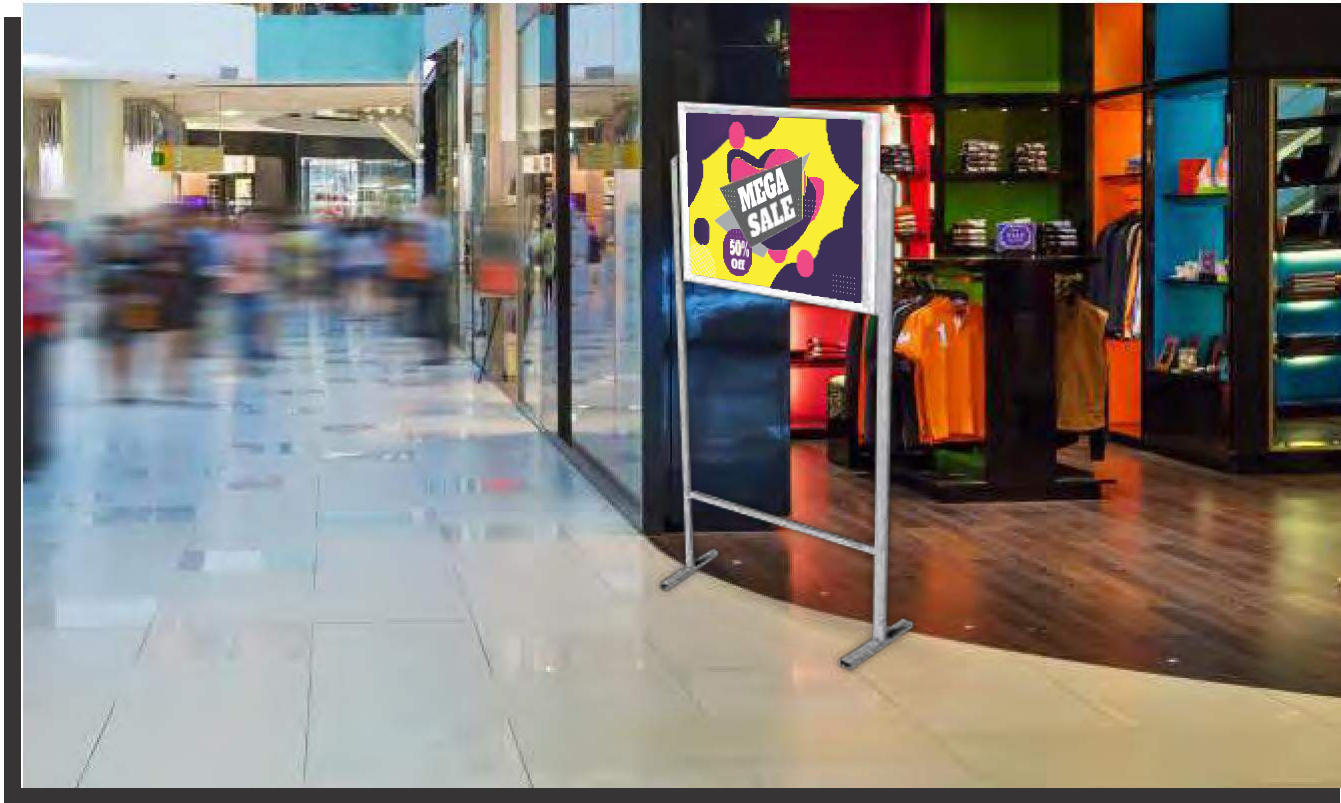

Code Description

| Code | Description |
|---------|--|
| BG9400 | Poster Frame Stand Double Sided A0 |
| BG9401 | Poster Frame Stand Double Sided A1 |
| BG9402 | Poster Frame Stand Steel Double Sided A2 |
| BG9402L | Poster Frame Stand Steel Double Sided A2 Landscape |
| BG9403 | Poster Frame Stand Steel Double Sided A3 |
| BG9403L | Poster Frame Stand Steel Double Sided A3 Landscape |

Portrait Max.
Height

Landscape Max.
Height

| | |
|--------|--------|
| 2135mm | 1960mm |
| 1960mm | 1858mm |
| 1858mm | 1750mm |
| 1858mm | 1750mm |
| 1750mm | 1642mm |
| 1750mm | 1642mm |

- Lockable castors (BG9400 & BG9401).
- Width adjustable for landscape or portrait display (BG9400 & BG9401).
- Can only be used with Poster Frames.
- Includes Double-Sided Poster Frame.

Lockable castors



Adjustable crossbar

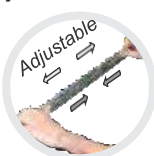

BG9400 & BG9401
Poster Frame Stand
Double-Sided for A0 & A1



BG9402(L) & BG9403(L)
Poster Frame Stand
Steel Double-Sided for A2 & A3

Poster Frames

Poster Frame Stand



| Code | Description | Base Size |
|---------|---------------------------------|-------------|
| BG9002 | Poster Frame Stand A2 Portrait | 318 x 245mm |
| BG9002L | Poster Frame Stand A2 Landscape | 318 x 245mm |
| BG9003 | Poster Frame Stand A3 Portrait | 318 x 245mm |
| BG9003L | Poster Frame Stand A3 Landscape | 318 x 245mm |
| BG9004 | Poster Frame Stand A4 Portrait | 318 x 245mm |

- Includes Poster Frame
- Suitable for A2, A3 & A4
- Angle adjustment on single sided frames
- Adjustable screw-in feet on single pole stands
- Base plate with single pole
- Assembles easily without tools
- Can only be used with Poster Frames

While stocks last



Poster Frames Supports

Poster Frame Stand - Double Upright



| Code | Description | Base Size | Height |
|---------|---------------------------------|-------------|--------|
| BG9000 | Poster Frame Stand A0 Portrait | 660 x 620mm | 1300mm |
| BG9000L | Poster Frame Stand A0 Landscape | 660 x 620mm | 1300mm |
| BG9001 | Poster Frame Stand A1 Portrait | 660 x 620mm | 1300mm |
| BG9001L | Poster Frame Stand A1 Landscape | 660 x 620mm | 1300mm |

- Includes Poster Frame.
- Suitable for A0 & A1.
- Angle adjustable on single sided frames
- Lockable castors on double pole stands.

- Base plate with double pole for A0 & A1 Poster Frames.
- Assembles easily without tools.
- Can only be used with Poster Frames.

While stocks last

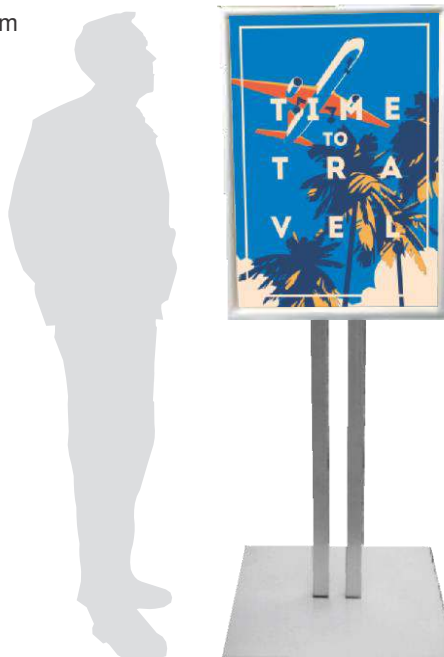

Poster Frames

Hanging System



| Code | Description | Size |
|---------|-------------------------------------|--------|
| BG9201* | Hanging Set Battens A1 | 600mm |
| BG9202* | Hanging Set Battens A2 | 430mm |
| BG9203* | Hanging Set Battens A3 | 310mm |
| BG9204* | Hanging Set Battens A4 | 220mm |
| BG9301 | Poster Frame Hanging System 1 meter | 1000mm |
| BG9302 | Poster Frame Hanging System 2 meter | 2000mm |

* Supplied with Rope - 1 metre

Hanging Battens

- Available for A1, A2, A3, & A4 posters

Hanging System

- Hanging hooks and screws included for hanging Poster Frames

Customizable sizes

Up to 3000mm in width (Left to Right)



Hanging Battens

Sign Frames

80 - 1200mm Wall Signs - Flush

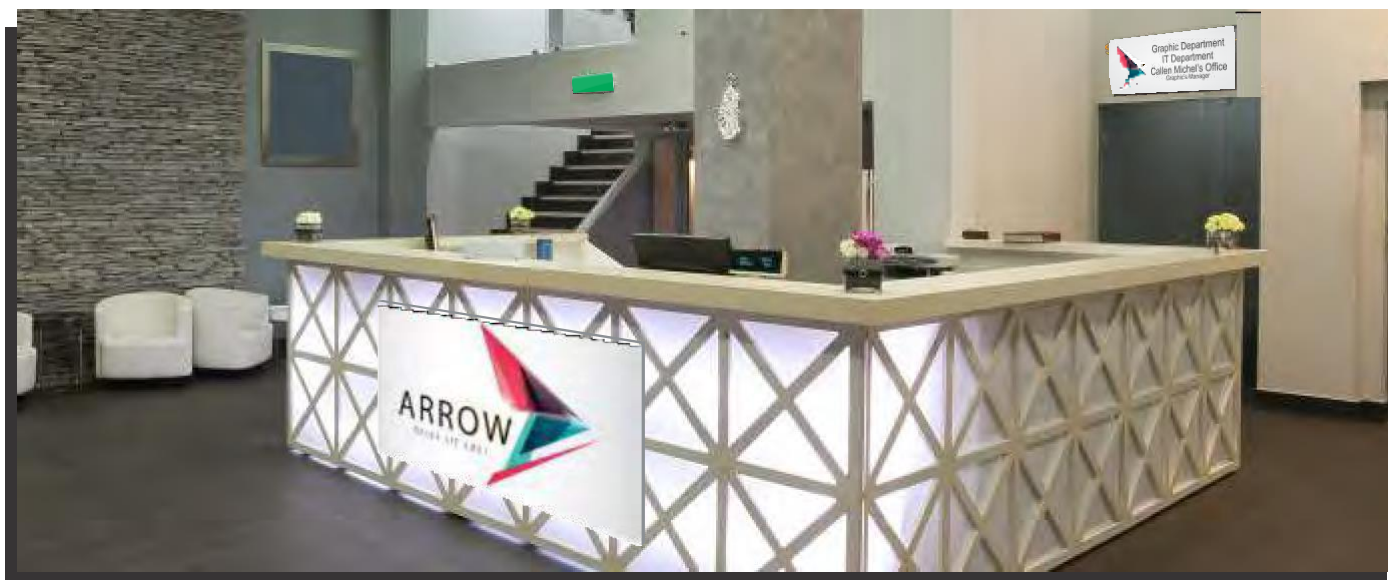

| Code | Description | Size | Code | Description | Size |
|--------|-----------------|-------------|---------|--------------------------|---------------|
| SF0820 | Sign Frame | 80 x 200mm | SF4106 | Sign Frame | 420 x 250mm |
| SF0830 | Sign Frame | 80 x 300mm | SF4110 | Sign Frame (A3) | 420 x 300mm |
| SF0840 | Sign Frame | 80 x 400mm | SF4112 | Sign Frame | 420 x 500mm |
| SF0850 | Sign Frame | 80 x 500mm | SF4114 | Sign Frame | 420 x 600mm |
| SF1030 | Sign Frame | 100 x 300mm | SF4116 | Sign Frame | 420 x 700mm |
| SF1040 | Sign Frame | 100 x 400mm | SF4118 | Sign Frame | 420 x 800mm |
| SF1050 | Sign Frame | 100 x 500mm | SF4202 | Sign Frame | 500 x 150mm |
| SF1060 | Sign Frame | 100 x 600mm | SF4204 | Sign Frame | 500 x 200mm |
| SF1230 | Sign Frame | 120 x 300mm | SF4206 | Sign Frame | 500 x 250mm |
| SF1530 | Sign Frame | 150 x 300mm | SF4208 | Sign Frame | 500 x 300mm |
| SF1540 | Sign Frame | 150 x 400mm | SF4210 | Sign Frame | 500 x 400mm |
| SF1550 | Sign Frame | 150 x 500mm | SF4212 | Sign Frame | 500 x 500mm |
| SF1560 | Sign Frame | 150 x 600mm | SF4214 | Sign Frame | 500 x 600mm |
| SF1570 | Sign Frame | 150 x 700mm | SF4216 | Sign Frame | 500 x 700mm |
| SF2020 | Sign Frame | 200 x 200mm | SF4218 | Sign Frame | 500 x 800mm |
| SF2040 | Sign Frame | 200 x 400mm | SF4302 | Sign Frame | 600 x 150mm |
| SF2129 | Sign Frame (A4) | 210 x 297mm | SF4304 | Sign Frame | 600 x 200mm |
| SF2140 | Sign Frame | 210 x 400mm | SF4306 | Sign Frame | 600 x 250mm |
| SF2145 | Sign Frame | 210 x 450mm | SF4308 | Sign Frame | 600 x 300mm |
| SF2150 | Sign Frame | 210 x 500mm | SF4310 | Sign Frame | 600 x 400mm |
| SF2160 | Sign Frame | 210 x 600mm | SF4312 | Sign Frame | 600 x 500mm |
| SF2170 | Sign Frame | 210 x 700mm | SF4314 | Sign Frame | 600 x 600mm |
| SF4002 | Sign Frame | 300 x 150mm | SF4316 | Sign Frame | 600 x 700mm |
| SF4004 | Sign Frame | 300 x 200mm | SF4318 | Sign Frame | 600 x 800mm |
| SF4006 | Sign Frame | 300 x 250mm | SF4320 | Sign Frame | 600 x 900mm |
| SF4008 | Sign Frame | 300 x 300mm | SF4422 | Sign Frame | 700 x 1000mm |
| SF4010 | Sign Frame (A3) | 300 x 420mm | SF4524 | Sign Frame | 800 x 1100mm |
| SF4012 | Sign Frame | 300 x 500mm | SF4520V | Sign Frame (A0) Portrait | 820 x 1189mm |
| SF4014 | Sign Frame | 300 x 600mm | SF4626 | Sign Frame | 900 x 1200mm |
| SF4016 | Sign Frame | 300 x 700mm | SF4726 | Sign Frame | 1000 x 1200mm |
| SF4018 | Sign Frame | 300 x 800mm | SF4828 | Sign Frame | 1100 x 1400mm |
| SF4102 | Sign Frame | 420 x 150mm | SF4929 | Sign Frame | 1200 x 1500mm |
| SF4104 | Sign Frame | 420 x 200mm | SF4976 | Sign Frame | 1200 x 2400mm |



| Code | Description | Size |
|---------|---|------------|
| SF0510 | Sign Frame | 50 x 100mm |
| SF0515 | Sign Frame | 50 x 150mm |
| SF0520 | Sign Frame | 50 x 200mm |
| SF0521 | Sign Frame | 50 x 210mm |
| SF0525 | Sign Frame | 50 x 250mm |
| SF0529 | Sign Frame | 50 x 297mm |
| SF0530 | Sign Frame | 50 x 300mm |
| SF0535 | Sign Frame | 50 x 350mm |
| SF0540 | Sign Frame | 50 x 400mm |
| SF0540S | Sign Frame with slide | 50 x 400mm |
| SF0545 | Sign Frame | 50 x 450mm |
| SF0550 | Sign Frame | 50 x 500mm |
| SF0560S | Sign Frame In/Out Slide & Message Strip | 50 x 600mm |
| BD4101 | Sign Frame In/Out Single Carded Retail | 50 x 400mm |
| BD4110 | Sign Frame In/Out Ten Boxed Retail | 50 x 400mm |
| SN1000 | Sign Frame Retail Pack | 50 x 280mm |



- Includes media cover, print not included
- Plastic end caps, masonry screws and plugs
- Aluminium Extrusion
- For indoor or outdoor use, depending on media used
- Includes message strip



Sign Frames

Double Sided - Standing



| Code | Description | Size |
|--------|-------------------------------|---------------|
| SF4040 | Sign Frame DBL Sided Standing | 300 x 1800mm |
| SF4140 | Sign Frame DBL Sided Standing | 420 x 1800mm |
| SF4240 | Sign Frame DBL Sided Standing | 500 x 1800mm |
| SF4340 | Sign Frame DBL Sided Standing | 600 x 1800mm |
| SF4440 | Sign Frame DBL Sided Standing | 700 x 1800mm |
| SF4540 | Sign Frame DBL Sided Standing | 800 x 1800mm |
| SF4640 | Sign Frame DBL Sided Standing | 900 x 1800mm |
| SF4743 | Sign Frame DBL Sided Standing | 1000 x 2100mm |
| SF4844 | Sign Frame DBL Sided Standing | 1100 x 2200mm |
| SF4946 | Sign Frame DBL Sided Standing | 1200 x 2400mm |

- Easy to change sign
- Custom sign graphic design and printing available but not included
- Powder Coated base and top
- Can be made to custom sizes
- For indoor and outdoor use, depending on media used



Sign Frames

Double Sided Wall mounted



Wall Signs - Double Sided

| Code | Description | Size | |
|---------|--|-------------|--|
| SF1030D | Sign Frame DBL Sided Wall Mounted (M) | 100 x 300mm | <ul style="list-style-type: none"> • (M) Includes media cover • Custom sign graphic design and printing available but not included • Powder coated end caps • Masonry screws and plugs • For indoor or outdoor use, depending on media used |
| SF2123D | Sign Frame DBL Sided Wall Mounted (M) | 210 x 230mm | |
| SF2129D | Sign Frame DBL Sided Wall Mounted (M) | 210 x 297mm | |
| SF2140D | Sign Frame DBL Sided Wall Mounted (M) | 210 x 400mm | |
| SF4030 | Sign Frame DBL Sided Wall Mounted (A3) | 300 x 420mm | |
| SF4130 | Sign Frame DBL Sided Wall Mounted (A3) | 420 x 300mm | |

Desktop Signs

| Code | Description | Size | |
|---------|--|-------------|--|
| SF2115H | Sign Frame Desk Top Landscape (A5) (M) | 210 x 148mm | <ul style="list-style-type: none"> • (M) Includes media cover • Powder coated end caps • Free standing • Custom sign graphic design and printing available but not included • SN1300 & SN1305 Plastic End Cap |
| SF2115V | Sign Frame Desk Top Portrait (A5) (M) | 148 x 210mm | |
| SF2129H | Sign Frame Desk Top Landscape (A4) (M) | 210 x 297mm | |
| SF2129V | Sign Frame Desk Top Portrait (A4) (M) | 210 x 297mm | |
| SN1300 | Sign Frame Desk Name Plate | 50 x 280mm | |
| SN1305 | Sign Frame Desk Name Plate Double Side | 50 x 280mm | |

Safety Signs



Red Print on White ACP



SN4101



SN4102



SN4103

Black Print on Brushed Aluminium ACP



SN4104



SN4105



SN4106

White Print on Black ACP



SN4107



SN4108



SN4109

Red and Black Print on White ACP



NO PARKING
SN4110



NO SMOKING
SN4111



NO ENTRY
SN4112

Green Print on White ACP



SN4113



SN4114



SN4115

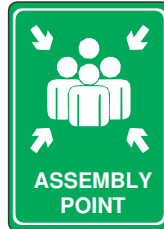

SN4116



SN4117

- 150 x 150 mm • Printed with UV print
- Double sided tape included
- Special signs made to order
- Assembly point sign A4 210 x 297mm
- Exit sign 150 x 300mm

Hospital Bed Boards



| Code | Description | Size |
|--------|-----------------------------|-------------|
| BD1703 | A3 Glass Hospital Bed Board | 297 x 420mm |
| BD1704 | A4 Glass Hospital Bed Board | 210 x 297mm |
| BD1705 | Glass Hospital Bed Board | 250 x 450mm |
| BD1710 | Glass Hospital Bed Board | 300 x 350mm |

Product Features

- 6mm Toughened Glass
- Includes 4x stainless steel wall mounts
- Customised prints and sizing available
- Easy to clean
- Non-porous and hygienic
- Scratch resistant
- Artwork to be supplied in high resolution tiff, jpeg, pdf or vector format



- Printing included (standard sized boards only)

Glass Splashbacks

Hobs Splashback



Select from our new standard range of 20 colours: *Metallic Colours will incur an additional cost ***

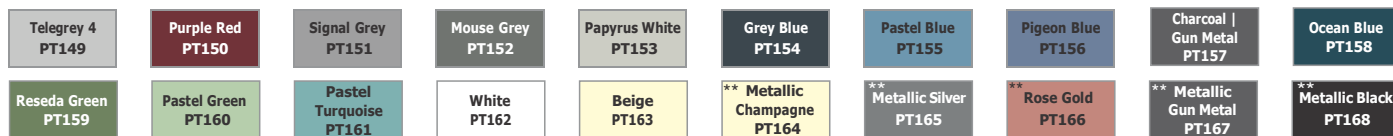

Select from our previous standard range of 25 colours: **While Stocks Last*

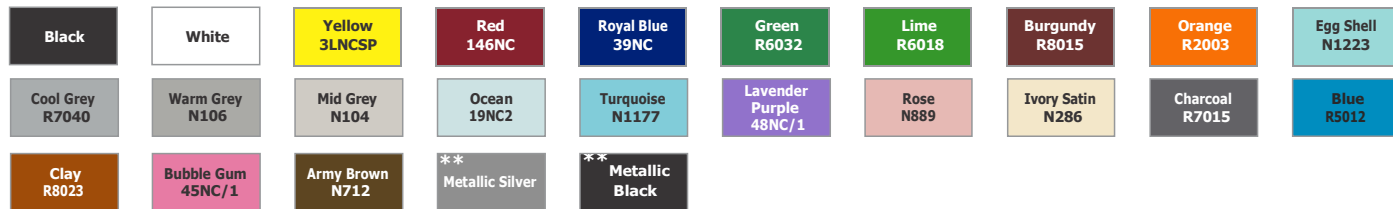

Colours can vary when printed on glass due to their refractory properties as well as the pureness of the clear glass.

Our new standard range of printed hobs



Code Description Size

| | | |
|---------|------------------|-----------------|
| GR017S | Glass Splashback | |
| SB6065* | Splashback Hob | 598 x 650 x 6mm |
| SB9070 | Splashback Hob | 898 x 700 x 6mm |

- SABS approved glass
- 6mm floated tempered/toughened glass
- Low maintenance and easy to clean
- Steam resistant
- Printing will not crack or fade
- Image is printed directly on the glass surface
- Mold and oil stain resistant

- No charge for standard electric and plumbing cutouts
- Can print up to 1500 x 3000mm
- Thicker glass is available on request
- Artwork to be supplied in high resolution tiff, jpeg, pdf or vector format
- Mounted with solvent free silicone

* **SB6065 Portrait Glass**

Customised Glass Splashback & Wall Art



Code Description

GR017S Glass Splashback

Product Features

- SABS approved glass
- 6mm opti-clear (low Iron) tempered/toughened glass
- Low maintenance and easy to clean
- Printing will not crack or fade
- Image is printed directly on the glass surface
- Mold and oil stain resistant
- No charge for standard electric and plumbing cutouts
- Thicker glass is available on request
- Artwork to be supplied in high resolution tiff, jpeg, pdf or vector format
- Mounted with solvent free silicone
- Measured using state of the art equipment for tailor fit finish

Acrylic Certificate Holder

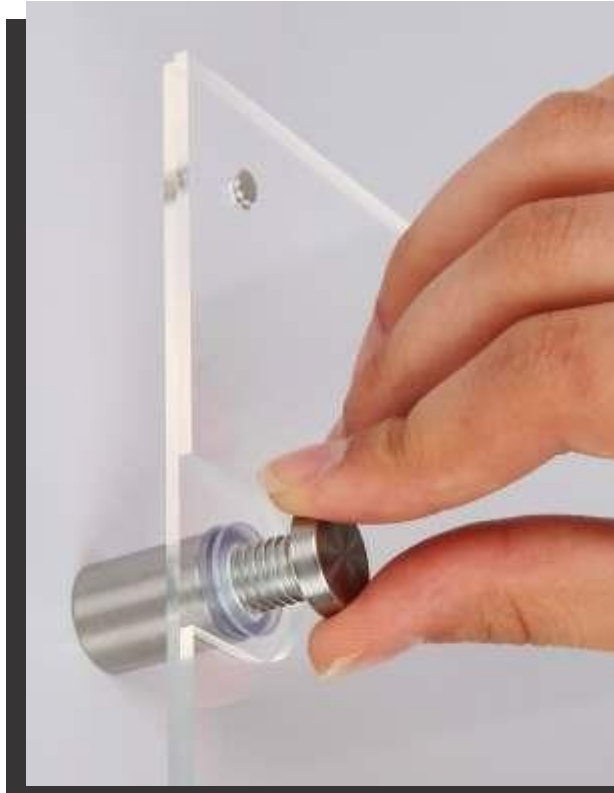

| Code | Description | Size |
|--------|----------------------------|------|
| DP2004 | Acrylic Certificate Holder | A4 |
| DP2003 | Acrylic Certificate Holder | A3 |

- Frameless display system
- Crystal clear acrylic finish - 2mm thick
- Suitable for office and reception areas
- Ideal for certificates and other general information
- Includes 4x stainless steel stand offs and mounting screws
- Easy to remove and update display
- Features a magnetic clip that holds display closed



Acrylic Display Holders



Code Description

DP0404 Flat Packable Laptop Stand

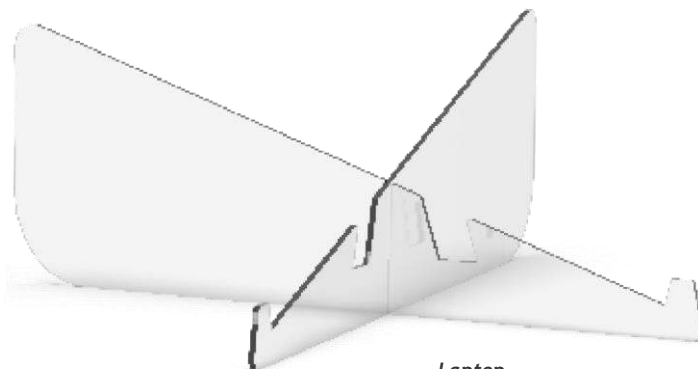

*Laptop
not included*

- Flat packable for easy storage
- Easy to set up
- Portable and light weight – fits in laptop bag
- Ergonomic
- Can be used as tablet stand for video conferencing
- Manufactured from durable 3mm clear acrylic

Code Description

DP0405 Tablet/ Cellphone Stand Acrylic Flat Pack



*Tablet/Cellphone
not included*

- 4mm Clear Perspex construction
- Portable and light weight
- Elevated design allows for heat dissipation and increased airflow beneath the cellphone or tablet, preventing overheating

Acrylic Display Holders

Single Sided Menu Holder

| Code | Description |
|-----------|---|
| DP0106L-Z | A6 Acrylic Menu Holder - Landscape - Box of 5 |
| DP0106P-Z | A6 Acrylic Menu Holder - Portrait - Box of 5 |
| DP0105L-Z | A5 Acrylic Menu Holder - Landscape - Box of 5 |
| DP0105P-Z | A5 Acrylic Menu Holder - Portrait - Box of 5 |
| DP0104L-Z | A4 Acrylic Menu Holder - Landscape - Box of 5 |
| DP0104P-Z | A4 Acrylic Menu Holder - Portrait - Box of 5 |

- A6, A5 & A4 made with 2mm thick Acrylic
- Ideal for restaurants, reception desks and business
- Single sided design with shaped foot
- Available in portrait and landscape



Double Sided Menu Holder

| Code | Description |
|-----------|---|
| DP0134-Z | 1/3 (DL) A4 Single Sided Acrylic Menu Holder - Box of 5 |
| DP0206L-Z | A6 Acrylic Menu Holder - Landscape - Box of 5 |
| DP0206P-Z | A6 Acrylic Menu Holder - Portrait - Box of 5 |
| DP0205L-Z | A5 Acrylic Menu Holder - Landscape - Box of 5 |
| DP0205P-Z | A5 Acrylic Menu Holder - Portrait - Box of 5 |
| DP0204L-Z | A4 Acrylic Menu Holder - Landscape - Box of 5 |
| DP0204P-Z | A4 Acrylic Menu Holder - Portrait - Box of 5 |
| DP0234-Z | 1/3 (DL) A4 Double Sided Acrylic Menu Holder - Box of 5 |

- A6, A5 & A4 made with 2mm thick Acrylic
- Ideal for restaurants, reception desks and business
- Double sided T design
- Available in portrait and landscape



Acrylic Table Talker & Table Brochure Holder

| Code | Description |
|----------|--|
| DP0305 | A5 Three Sided Acrylic Table Talker |
| DP0506-Z | A6 Standard Acrylic Table Brochure Holder - Box of 5 |
| DP0505-Z | A5 Standard Acrylic Table Brochure Holder - Box of 5 |
| DP0504-Z | A4 Standard Acrylic Table Brochure Holder - Box of 5 |

- DP0305:**
- 2mm Acrylic construction
 - Three side viewing

- DP0506, DP0505 & DP0504:**
- A6, A5 & A4 made with 2mm thick Acrylic
 - Ideal for restaurants, reception desks and business
 - 30mm in depth



Table Talker

Designer Mounting Systems

Ceiling Hanging Systems, Floor to Ceiling Systems



| Code | Description | Size |
|--------|--------------------------------|-------------|
| DM5020 | Single-sided clamp | 3000mm |
| DM5030 | Double-sided clamp | 21mm x 15mm |
| DM5110 | Ceiling Hanging Grip and Cable | 39mm x 15mm |
| DM5200 | Cable floor to ceiling | 1000mm |

- Aluminium with a satin finish
- Accommodates panels 3-8mm
- Can be used with glass, aluminium composite panel, acrylic, etc
- Masonry screws, wall plugs and allen key are included
- Sign material excluded
- Custom graphic design and printing available but not included

While stocks last



DM5020



DM5030



DM5110



DM5200

** Images are not to scale*

Designer Mounting Systems



Code Description

| | |
|--------|---------------------------------|
| DM3000 | Aluminium Wall Clamp 80mm |
| DM3001 | Aluminium Wall Clamp 120mm |
| DM3002 | Aluminium Wall Clamp 180mm |
| DM4100 | Aluminium Standoff 4 Way |
| DM8000 | Aluminium Side Wall Clamp |
| DM8100 | Stainless Steel Standoff Single |
| DM8101 | Chrome Standoff Edge Grip |

While stocks last

DM3000



DM3001



DM3002



DM4100



DM8000



DM8101



DM8100



** Images are not to scale*

Designer Mounting Systems



Code Description

| | |
|--------|---|
| DM5000 | Aluminium Free Standing Frame Kit |
| DM5010 | Aluminium Cable Wall Fixture Set |
| DM5020 | Aluminium Cable Material Clamp Single Sided |
| DM5030 | Aluminium Cable Material Clamp Double Sided |
| DM5100 | Aluminium Floor to Ceiling Channel |
| DM5300 | Aluminium Cable System Floor to Ceiling Channel Set |

While stocks last

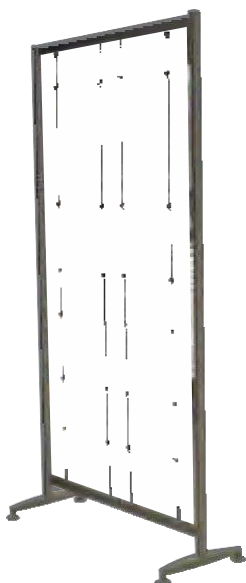

DM5000



DM5010



DM5020



DM5030



DM5100



DM5300

** Images are not to scale*

Glass Cube Display Stand

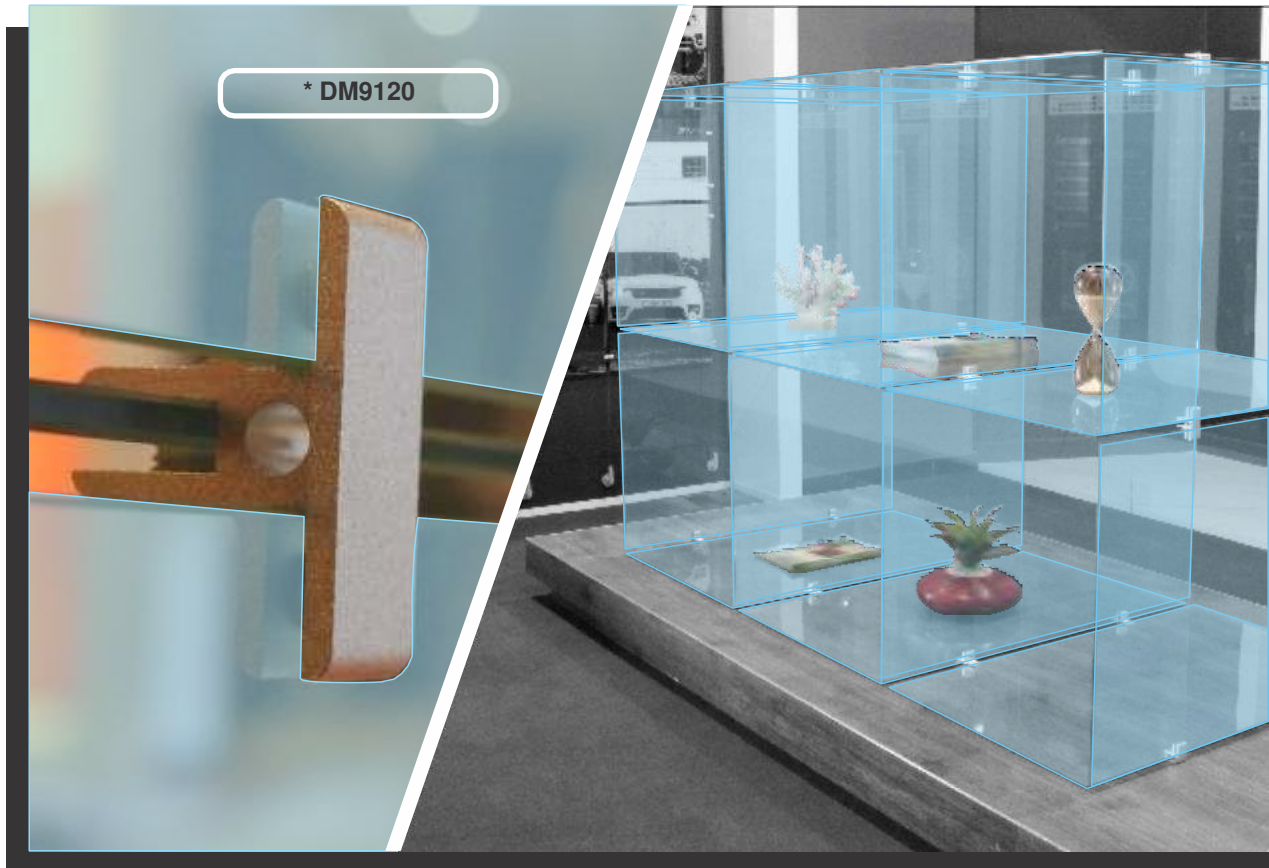

| Code | Description | Size |
|--------|----------------|----------------|
| DM9110 | Two way grip | 38 x 38 x 38mm |
| DM9120 | Three way grip | 58 x 38 x 38mm |
| DM9130 | Four way grip | 58 x 38 x 58mm |

- Aluminium with a satin finish
- Accommodates panels 6-8mm
- Can be used with glass, aluminium composite panel, acrylic, etc.
- Material excluded
- Multiple design layouts
- Phillips screwdriver is required
- Custom graphic design and printing available but not included

While stocks last



DM9110



DM9120



DM9130

Retractable Q-Barrier system



| Code | Description | Dimensions |
|---------|---|-------------------|
| DP9132 | Retractable Queue Barrier Chrome with Black Belt | 320 x 320 x 910mm |
| DP9132R | Retractable Queue Barrier Chrome with Black Belt - Box of 2 | 320 x 320 x 910mm |

- Dimensions 320 x 320 x 910mm
- Barrier feature a heavy weighted 7.5kg base with rubberized floor protector
- System comes with a retractable 2 meter black belt
- 4-Way Connection: for convenient control management setups
- The system has a high polished chrome finish
- Endless Uses: perfect for crowd control at retail stores, sporting arenas, airports, banks, registrations, hotels, concert venues, trade shows etc



Janitorial Dispenser Stand



| <i>Code</i> | <i>Description</i> |
|-------------|-----------------------------------|
| JA0502SS | Dispenser Stand - Stainless Steel |

JA0502SS features:

- Floor standing soap or sanitizer dispenser stand
- Stainless Steel Construction
- Highly durable design
- Drip tray
- To be used in conjunction with:
JA0502AS or JA0502AG
- Height : 1440mm



** Dispenser not included*

Hand Soap

JA0401HS

| Code | Description |
|------|-------------|
|------|-------------|

| | |
|----------|-------------------------------|
| JA0401HS | Janitorial Hand Soap - 5Litre |
|----------|-------------------------------|

- Scented
- Gentle on skin
- Reduces germs
- Protects hands



Hand Sanitizer

| Code | Description |
|------|-------------|
|------|-------------|

| | |
|----------|-----------------------------------|
| MEDHS03 | Hand Sanitizer - 5Litre |
| MEDHS02Z | Hand Sanitizer - 250ml (Box of 6) |
| MEDHS01Z | Hand Sanitizer - 28ml (Box of 20) |

Sanitizer Features:

- Antibacterial • Antiviral
- Antifungal Sanitizing solution
- 90% Iso Propyl Alcohol

MEDHS03



MEDHS02Z



MEDHS01Z



Surface & Hand Sanitizer

| Code | Description |
|------|-------------|
|------|-------------|

| | |
|----------|--|
| MEDHS04 | Surface & Hand Sanitizer - 400ml Aerosol Single |
| MEDHS04Z | Surface & Hand Sanitizer - 400ml Aerosol Box of 12 |

- A fast and effective Sanitizing Solution to help reduce bacteria & viruses on skin & surfaces.
- Ideal for hands and surfaces
- Citrus Scented,
- Antibacterial, Antiviral & Antifungal Sanitizing Solution



Aerosol
400ml
Spray Can



While stocks last

Janitorial Chemical Range



Code Description

JA0401DC Janitorial Toilet Cleaner

- Features:**
- Dilute 35ml with water



Code Description

JA0401WC Janitorial Window Cleaner

- Features:**
- Dilute 1:10 with water



Code Description

JA0401TC Janitorial Tile Cleaner



Note: Maximum temperature for storage is +/- 30 degrees°C • Store in a cool, dark place out of direct sunlight

Code Description

JA0401B Janitorial Bleach 3%



Code Description

JA0401D Janitorial Dishwashing Liquid



Code Description

JA0401H Janitorial Handy Klean



Note: Maximum temperature for storage is +/- 30 degrees°C • Store in a cool, dark place out of direct sunlight

Janitorial Re \square llable Bottles

| Code | Description | QTY | Size |
|-----------|--|------------|-------|
| JA0401S | Bottle 250ml and Spray Cap Single | 1 | 250ml |
| JA0401SP | Bottle 250ml | Box of 250 | 250ml |
| JA0401C | Cap 250ml Bottle | Box of 250 | |
| JA0401HB | Refillable Bottle for Handy Kleen | Box of 12 | 750ml |
| JA0401BB | Refillable Bottle for Bleach | Box of 12 | 750ml |
| JA0401WB | Refillable Bottle for Window Cleaner | Box of 12 | 750ml |
| JA0401SB | Refillable Bottle for Dishwashing Liquid | Box of 12 | 750ml |
| JA0401DB | Refillable Bottle for Toilet Cleaner | Box of 12 | 750ml |
| JA0401AB | Refillable Bottle for Assorted | Box of 5 | 750ml |
| JA0401JSE | Bottle 5L Jerry 120g and Cap Single | 1 | 5L |
| JA0401JE | Bottle 5L Jerry 120g | Box of 24 | 5L |
| JA0401JSM | Bottle 5L Jerry 160g and Cap Single | 1 | 5L |
| JA0401JM | Bottle 5L Jerry 160g | Box of 24 | 5L |
| JA0401JSP | Bottle 5L Jerry 200g and Cap Single | 1 | 5L |
| JA0401JP | Bottle 5L Jerry 200g | Box of 24 | 5L |
| JA0401JC | Cap Sandard 5L Jerry | Box of 24 | |
| JA0401JCS | Cap Sandard 5L Jerry | Box of 150 | |

* All bottles are empty and should be used in conjunction with Parrots Janitorial Cleaning Chemicals

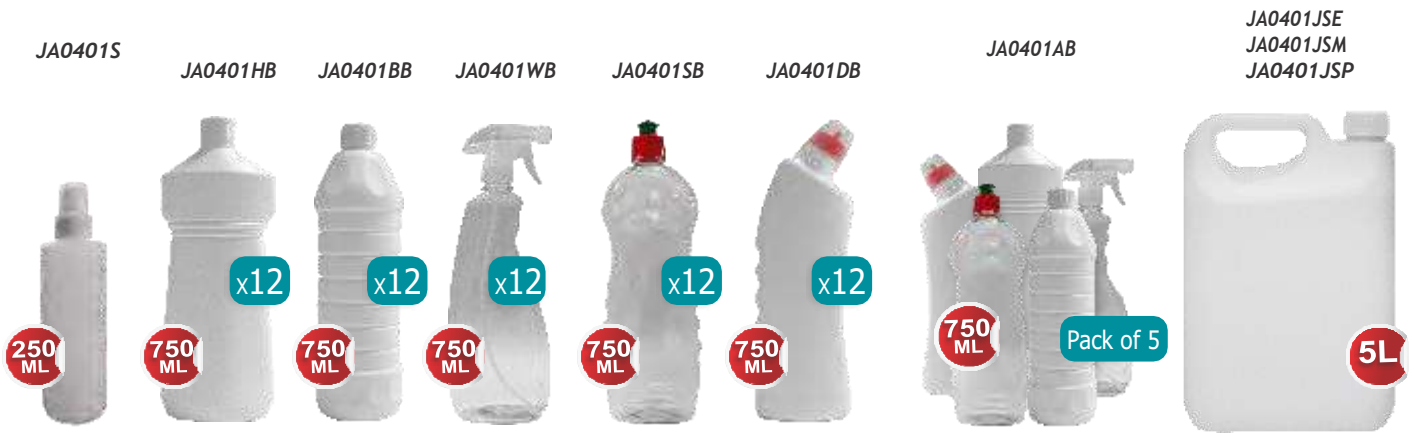

Refuse Disposal

Touchless Bin

| Code | Description |
|--------|--------------------------|
| JA0801 | Janitorial Bin Touchless |

Product Features

- 50L bin capacity
- Stainless steel casing
- Infrared motion sensor with automatic opening & closing
- 6 x AA battery operated (not included)
- Low battery power consumption
- Ideal for use in homes, kitchens & offices
- Firm fit lid helps reduce odours
- Touch free operation helps reduce contamination of germs
- Bin size: 42*31.5*61cm

50L
CAPACITY



Refuse Bags

| Code | Description | Size |
|---------|----------------------------------|-------------|
| JA0402R | Janitorial Refuse Bags 28 Micron | 750 x 950mm |

Product Features

- Interleaved
- 28 Micron
- Made from 60% recycled material
- 100% Recyclable
- Size: 750 x 950mm
- Fits most household bins
- Available in black only

80L
CAPACITY

20
BAGS



Janitorial Dispensers

Desktop Dispenser

Code Description

JA0502DS Desktop Sanitizer Dispenser - Auto
 JA0502DG Desktop Soap Dispenser - Auto

- Automatic desktop dispenser
- Infrared sensor - touch free
- Ideal for home and office use
- No installation required
- Refillable 500ml bottle
- Ideal for gel soaps and lotions / liquid sanitizers
- Requires 4 x AA Batteries - not included



JA0502DG



JA0502DS

Dispenser Plastic

Code Description

JA0502AS Sanitizer Dispenser - Auto
 JA0502AG Soap Dispenser - Auto

- Automatic gel or spray dispenser
- Infrared sensor touch free
- Refillable 1000ml bottle
- Easily converts to gel or spray dispenser
- Lockable
- Requires 6 x AA Batteries (Not included)
- Spare nozzles available:
 JA0502G – Gel / JA0502S – Spray
- Spare bottle available: JA0502BA



Code Description

JA0502MS Sanitizer Dispenser - Manual
 JA0502MG Soap Dispenser - Manual

- Manual gel or spray dispenser
- Refillable 1000ml bottle
- Easily converts to gel or spray dispenser
- Lockable
- Includes spray nozzle
- Spare nozzles available:
 JA0502G – Gel / JA0502S – Spray
- Spare bottle available: JA0502BM



Dispenser Stainless Steel

Code Description

JA0503AG Dispenser Automatic - Gel Pump
 JA0503AS Dispenser Automatic - Spray Pump

- Automatic dispenser
- Mirror finish 304 stainless steel
- Infrared sensor, touch free
- Refillable 1000ml bottle
- Easily converts to gel or spray dispenser
- Lockable with keys
- Requires 6 x AA Batteries (Not included)
- Includes mounting screws & wall plugs



Code Description

JA0503MG Dispenser Manual - Gel Pump
 JA0503MS Dispenser Manual - Spray Pump

- Manual dispenser
- Mirror finish 304 stainless steel
- Easy push mechanism
- Refillable 1000ml bottle
- Easily converts to gel or spray dispenser
- Lockable with keys
- Includes mounting screws & wall plugs



Janitorial Dustpan & Brush

Code **Description**

JA0102 Janitorial Dustpan and Brush Set

- Light weight
- Ideal for soft and hard surfaces
- Quality fibre for effective sweeping
- Ergonomic handle for comfort while in use
- Rubber lip assists with the collection of dirt by ensuring contact between the dustpan & floor

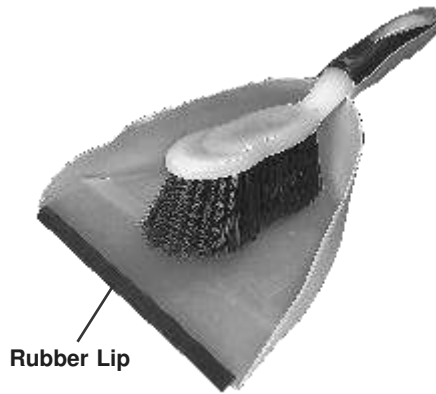

Janitorial Bucket 14L

Code **Description**

JA0702 Janitorial Bucket 14L

- Ergonomic carry handle
- Pour spout
- Strong durable design
- Rectangular shape, fits most standard mops and rollers
- **Ideal for use with:** JA0301 (Janitorial Mop PVA Double Roller)



Code **Description**

JA0104 Janitorial Rubber Broom

Features:

- Ideal to sweep up dust, pet hair or liquids & around the pool side
- Durable 500G rubber head
- 300mm wide
- 1400mm handle



Code **Description**

JA0101 Janitorial Soft Broom

Features:

- Light Weight
- 300mm Soft Head
- 1200mm Powder Coated Handle
- Quality fibre for effective sweeping



Coming Soon

Janitorial Accessories

Code Description

JA0103 Janitorial Yard Broom Hard Bristle - 450mm

Features:

- 450mm plastic molded hard bristle broom
- Cushioned grip handle for additional comfort.
- 1200mm powder coated handle
- Light weight
- Weather & impact resistance
- Quality fibre for effective sweeping

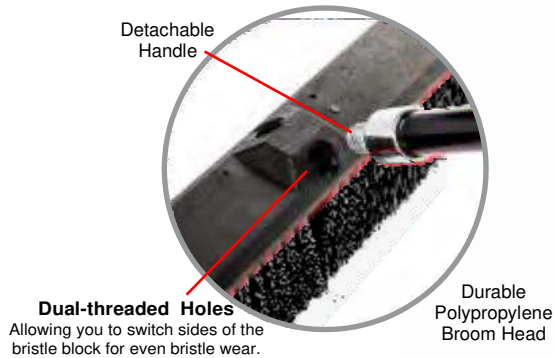

Code Description

JA0202 Janitorial Fan Mop - 400g

Features:

- 400g Mop Head
- 100% Cotton
- 1200mm Aluminium Handle
- High Quality
- Super Absorbent



Code Description

JA0301 Janitorial Mop PVA Double Roller

Features:

- Double Roller Mechanism
- Super absorbent PVA sponge
- Retractable handle for ease of use
- Soft-grip handle

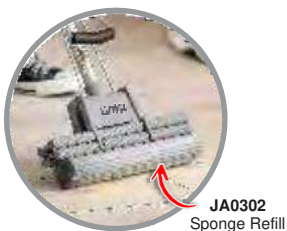

Code Description

JA0204 Microfibre Floor Sweeper Mop

Features:

- Lightweight high strength aluminium design
- Refillable on-board 600ml reservoir – add water and floor chemical of your choice.
- Fan shaped spray to easily wet and clean floors
- Swivel head for difficult to reach corners
- 2 x microfibre wash pads are included in JA0204
- Microfibre wash pads can be easily removed and are machine washable.





Micro Fibre Cloth

Code **Description**

JA0901 Janitorial Micro Fibre Cloth 280GSM (pack 5)

- Highly absorbent, machine washable cloth
- Removes grease and grime
- Safe on all surfaces
- 280GSM
- 300 X 300mm

Coming Soon



Bubble Wrap

Code **Description**

PM0100 Bubble Wrap

- Bubble wrap roll, perfect for protecting all sensitive and fragile items from breaking and scratching.
- 1250mm width
- 100 meter length



Index

| | | | |
|---|---------|---|---------|
| Abacus 100 Beads | 42 | Headphones - Wireless & Wired | 96 |
| Adaptors | 103 | Highlighters - Slimline | 53 |
| Acrylic Display holders | 122-123 | Highlighters - Chisel Tip | 53 |
| Aerosol Whiteboard Cleaner | 48 | Hospital Glass Board | 118 |
| Air-mouse Keyboard | 93 | In/Out Boards | 40 |
| A-Frame Boards - Aluminum Frame | 31 | Info Boards – Alufine Frame & Aluminium Frame | 19-20 |
| A-Frame Boards - Steel Frame | 31 | Installation | 13 |
| A-Frame Boards - Poster Frame | 31 | Interactive Touch LED Panels | 78 |
| Alufine Magnetic boards | 5 | Interactive Whiteboard System - IR Board | 79 |
| Board Supports - Easels & T-legs | 28 | Keystone Adjusters | 87 |
| Bulletin Boards - Aluminium Frame, Carpet | 21 | Laminator Consumables | 67 |
| Cables | 103 | Laminators | 66 |
| Cast Acrylic Planners | 36 | Laser Pointers | 88 |
| Ceiling Box | 88 | Lectern & Wireless Mic | 98 |
| Ceiling Mounting Bracket, Projectors Cage | 83 | LED Modular Display | 104-105 |
| Certificate Holder | 121 | Magnetic Label Carriers | 46 |
| Chalk & Chalk Holder | 48 | Magnetic Map Pins | 46 |
| Chalk Boards - Magnetic | 9 | Magnetic Photo Paper & Tape | 45 |
| Chalk Boards - Non Magnetic | 9 | Magnetic Ruler ACP | 44 |
| Clipboards | 15 | Media Cover | 108 |
| Comb Binding Machines | 59-60 | Megaphone | 77 |
| Combi Boards | 22 | Microphone USB | 100 |
| Craft Knives, Blades, Rotary | 61 | Mobile Bluetooth Speaker | 95 |
| Custom Products | 34-35 | Mobile / Revolving Boards | 29 |
| Data Projectors | 82 | Mops & Brooms | 134-135 |
| Dispensers - Auto & Manual | 133 | Moulded Magnets | 45 |
| Display Cases - Hinged Doors | 23 | Moulded Magnets - Extra Strength | 45 |
| Display Cases - Sliding Doors | 23 | Monitor Clamp Bracket | 89 |
| Drawing Pins & Push Pins | 46 | Office Equipment & Whiteboard Cleaner | 48 |
| Dusters | 47 | Paper Gripper, Multi Purpose | 32 |
| Dustpan & Brush | 134 | Pen and Eraser Holder Magnetic | 47 |
| Easy Rail System | 32 | Permanent Markers - Bullet Tip | 50 |
| Earphones - Wireless & Wired | 95 | Permanent Markers - Chisel Tip & Ultra Finline | 50-51 |
| Educational Boards - CKS Compliant | 10-12 | Perpetual Year Planners - Magnetic & Glass | 37-38 |
| Erasers & Aqua Wipe | 47 | Pin Boards, No Frame, Felt | 18 |
| Flexible Magnetic Strips & Shapes | 44 | Poster Frame Stand - Double Sided | 109 |
| Flexible Magnetic Sheeting | 43 | Poster Frames - Double-sided Upright | 111 |
| Flipchart Accessories - Flipchart Paper | 27 | Poster Frames - Mitred Econo, Mitred Corner, Plastic | 106 |
| Flipchart Paper Carrier | 27 | Poster Frames - Chrome Corner, Security Frame | 107 |
| Flipchart Carry Bag | 27 | Poster Frames - Window Frame & Magnetic Self Adhesive | 107-108 |
| Flipchart - Standard Models | 24 | Poster Frames - Hanging System | 112 |
| Flipchart Castors | 25 | Power Plugs | 103 |
| Floating Glass Whiteboard | 5 | Projectors | 82 |
| Glass Boards - Magnetic & Non Magnetic, Printed | 6-8 | Projector Screens - Screen Ratio | 84 |
| Glass/Chalkboard Markers | 52 | - Pulldown | 85 |
| Guillotines | 63 | - Tripod | 86 |
| Graphic Tablet Wired | 92 | - Electric | 87 |

Our Added Value to you

| | |
|---|---------|
| Projector Trolleys | 84 |
| Punches | 74-75 |
| Push Pins & Drawing Pins | 46 |
| Refillable Bottles | 132 |
| Retractable Q-Barrier System | 128 |
| Rotary Trimmers | 64-65 |
| Safety Signs | 117 |
| Sanitizers | 130 |
| Shredder Comparisons | 58 |
| Shredders | 54-57 |
| Splashbacks - Kitchen, Bathroom, Glass Wall Art | 119-120 |
| Signage - Flush Wall Signs | 113-114 |
| Signage - Double Sided Wall Signs | 116 |
| Signage - Landscape & Portrait Desk Signs | 116 |
| Signage - Double Sided Standing Signs | 115 |
| Signage - Ceiling Mounts | 124 |
| Signage - Modular Mounting System | 125-126 |
| Signage - Glass Cube Display Stand | 127 |
| Slimline Whiteboards - Non Magnetic and Magnetic | 1-2 |
| Speaker Sound Bar | 93-94 |
| Staple Remover | 73 |
| Staplers | 68-72 |
| Staples | 73 |
| Surface Mounted In/Out Slides | 39 |
| T-Legs | 28 |
| Tripods - Mini, Econo & Deluxe | 90 |
| Video Conference Camera | 99 |
| Visualizers | 101 |
| Vinyl Lettering / Vinyl Lining Tape | 43 |
| Webcam | 100 |
| Whiteboard Magnetic Eraser | 47 |
| Whiteboard Cleaner | 48 |
| Whiteboard Markers - Bullet Tip | 49 |
| Whiteboard Markers - Slimline Tip | 49 |
| Whiteboard Starter Packs | 48 |
| Whiteboards - Magnetic | 4 |
| Whiteboards - Non-Magnetic | 3 |
| Whiteboards - Mini Tiles Magnetic | 17 |
| Wireless Presentation Unit | 101 |
| Wooden Frames | 41 |
| Write 'n Wipe, Flexi-Mag | 17 |
| Writing Slates - Chalk Board, Whiteboard, Plastic & LCD | 14-16 |



PRE-SALES

- Free consultations
- Free demo & training sessions
- Free site inspections

01



IN-SALES

- Distribution
- Installation
- Commissioning

02



AFTER-SALES

- Training
- Remote and on-site support & ongoing consultations

03

